

DOU YEE
ENT ER P R I S E S

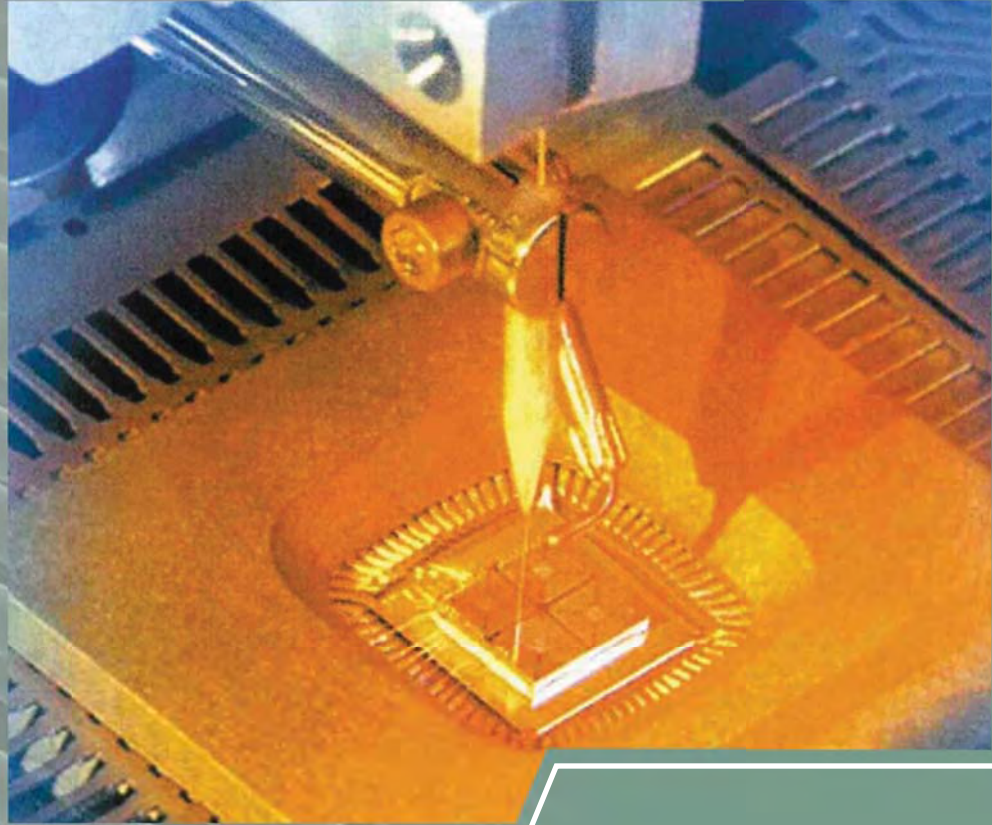

BONDING CAPILLARY

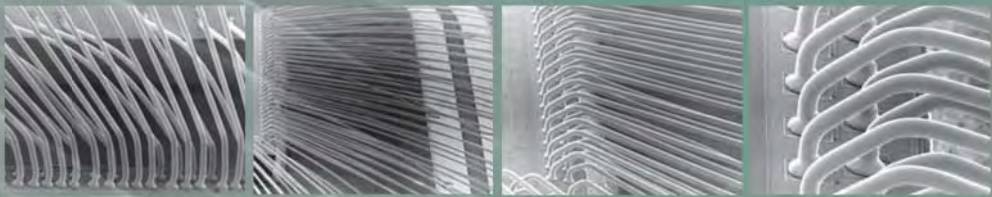

TOWARDS BONDING EXCELLENCE



CONTENTS

Company Profile	01
About Dou Yee - Global Capability, Local Focus Our Vision - Bonding Tool	
Product Excellence. Customer Partnership	02
The Bonding Cycle	03
The Longer Lifespan Capillary	06
HMX Capillary 	08
Ruby Capillary	10
Capillary Manufacturing Process	11
Quality Assurance/ Inspection System	12
Capillary Features	13
Chamfer Ball Control (CBC) Design Tail Bond Enhancer	
Special Bondings	14
Stud Gold Ball Bump Capillary Bond Stitch On Ball (BSOB) Bonding	
Capillary Design Rules	15
Capillary Parameter Selection Guide	18
Capillary Hole Diameter (H) Capillary Chamfer Diameter (CD) Capillary Inner Chamfer Angle (ICA) Capillary Tip Diameter (T) Capillary Tip Finishing (P,M & HMX) Capillary Face Angle (FA) Capillary Outer Radius (OR)	
Standard Capillary Dimensions Table	23
Fine Pitch Capillary Dimensions For 60 µm B.P.P And Above Table	24
Ultra-Fine Pitch Capillary (CBC Design) Dimensions For 55 µm B.P.P And Below Table	25
P/No System	26
Standard Capillary Fine-Pitch Capillary Ultra-Fine Pitch Capillary Vertical Bottleneck Capillary HMX Capillary Ruby Capillary	
Tolerances	32
Cap Cleaning Service	33
Unplug Wire	34
Packing Information/ Colour Coding/ Bar Code Label	35
Capillary Request From	36
Dou Yee Group Worldwide Office Addresses	

COMPANY PROFILE

ABOUT DOU YEE

Global Capability, Local Focus

Dou Yee is a premier total industrial solutions provider in worldwide. It has vast experience in static control, micro-contamination control and various specialized tools and materials required in the semiconductor, disk drive, electronic and other precision technology sectors since 1982.

Over the years, our customers have come to rely on us for products that are superior in quality, complete in range, competitive in pricing and timely in delivery. We have established long-term strategic alliances worldwide, with a global network that spans more than 35 branch offices in 15 countries.

With dynamic experienced and dedicated teams in many parts of the world, Dou Yee aims to become world's top provider of industrial solutions, offering world-class products and services of the highest standards to our valued customers.

The ISO9001:2000 and ISO14001 EMS certifications bear testimony to compliance with stringent international standards from the manufacturing process to the delivered product.

OUR VISION

Bonding Tool

Dou Yee aims to become worldwide leading supplier of bonding capillaries in the semiconductors, LED electronics industry.

Our sales and application staff are dedicated to take the extra miles in providing total bonding professional solutions to our customers' different needs and building up a strong relationship with them.

From the design centre to factory, Dou Yee is positioned to be a world class high technology bonding capillary manufacturer with state-of-the-art machinery and manufacturing capabilities.

Dou Yee Head Office



Dou Yee Technologies (Singapore)



Malaysia Manufacturing plant



China Manufacturing plant



Cert. No: Q7721



Cert. No: TW02/54422EM

PRODUCT EXCELLENCE. CUSTOMER PARTNERSHIP

PRODUCT INNOVATIONS. EXCELLENCE.

Our *Ceramic Injection Molding* technology; in-house material scientists' feedstock formulations; unique sintering process; proprietary-design secondary processes equipment; and manufacturing know-how; bear testimony to our commitment to ensure our capillaries are of the highest quality in order to be at the forefront of the ever demanding wire bonding challenges.



CUSTOMER PARTNERSHIP. INNOVATIVE SOLUTIONS.

Our commitment to customer partnership is one of the key elements to our success. In today's bonding process where more challenging and complex problems present itself, besides customizing capillary to suit each individual customers' requirements, Dou Yee also offers proactive support in areas of capillary design, process evaluation and optimization, problem analysis and training seminars. Constantly anticipating new technology trends is also a trait of our engineering team who keeps a "think-out-of-the-box" attitude to meet customers' new bonding requirements.



Our local warehousing facilities in many parts of the world and advanced logistics management system ensure timely delivery to our customers.





OUR SUCCESS FORMULA.

In Dou Yee, we are committed to the belief that the basis of our business is you, our customers. We strive to ensure customer satisfaction because meeting and fulfilling our customers' needs and expectations is the reason for our existence. We firmly believe in building up a long-term partnership with you.

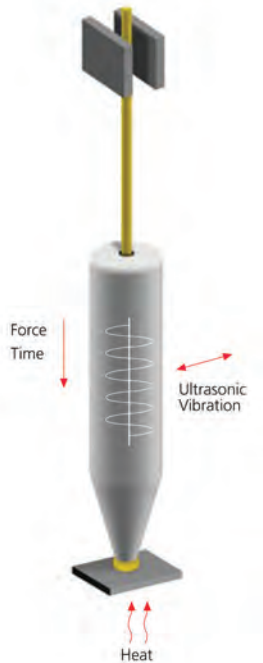
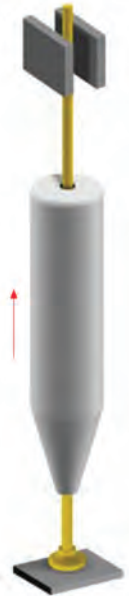

THE BONDING CYCLE

			
STAGE 0	STAGE 1	STAGE 2	STAGE 3
<p>In most cases, the cycle begins with the wire threaded through the capillary and a ball formed on the tail. Theoretically, the process starts with the ball creation but since in all machines, the ball is formed after the second bond, this will be addressed later.</p>	<p>The capillary is first moved by the machine to a position above the target pad in the x-y plane. With manual machines, the operator aims the capillary using a spotlight. New automatic machines do this with a PRS that controls the machine. The machine then lowers the capillary.</p> <p>During this stage, the wire (with the drag clamps) and the ball enter the capillary chamfer. Here, the ball's centering actions takes place. The centering action in capillaries with a 90° chamfer is usually more effective than with the 120°.</p>	<p>As the ball touches the pad, the creation of the first ball is underway. With force applied by the machine-controlled capillary tip and ultrasonic energy transmitted through the capillary, the ball is squashed and the first bond formed.</p> <p>The capillary chamfer acts by gripping the ball and mechanically delivering the ultrasonic vibration to the bond area. The chamfer's shape allows it to control the amount of gold squeezed in and around the first bond diameter.</p>	<p>Now the looping begins. After the first bond is formed, the capillary is raised, leaving wire to make the loop. This motion starts by rising to the kink height.</p>

THE BONDING CYCLE

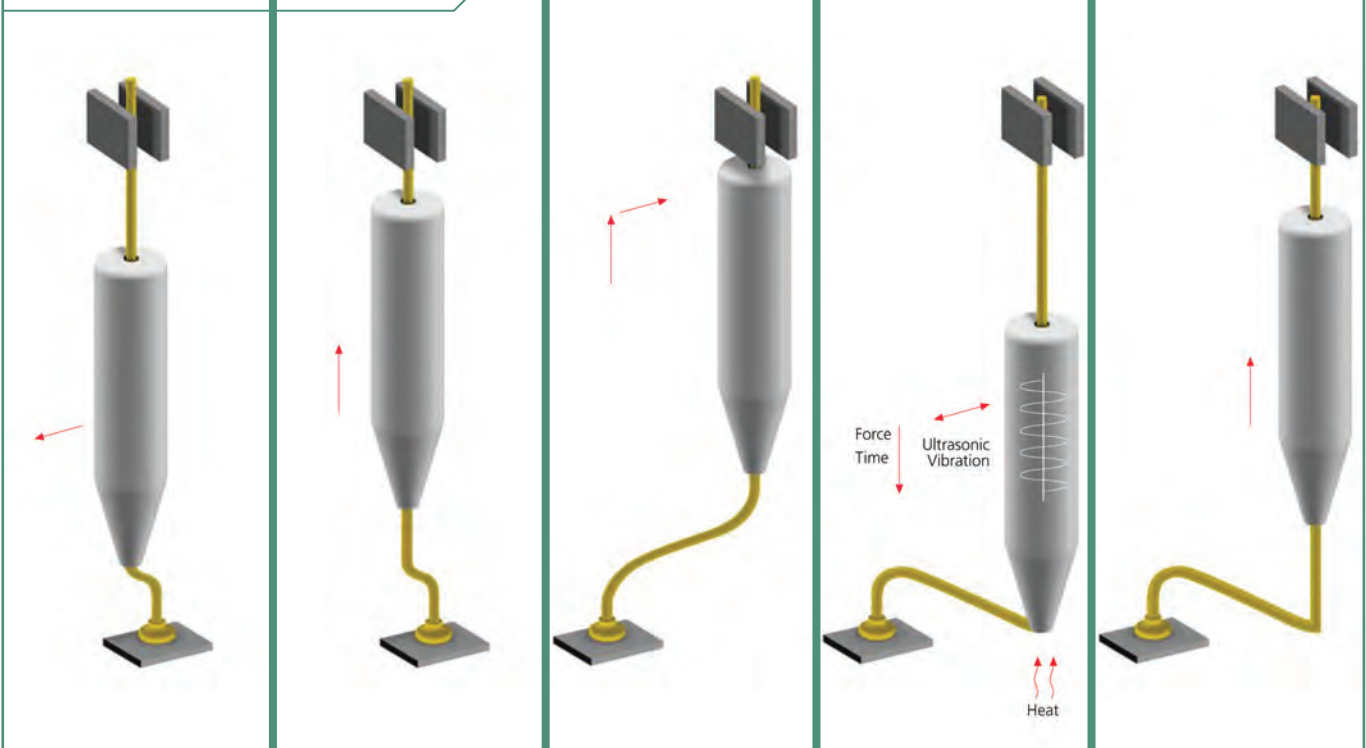

STAGE 4	STAGE 5	STAGE 6	STAGE 7	STAGE 8
<p>The capillary then moves in the opposite direction of the loop, away from the target lead. This kink leaves a small part of the wire bent in such a way that after the loop is formed, the wire above the bond is directed upwards, without breaking the wire just over the neck. Since the wire is bent during this reverse motion, a highly polished chamfer and hole are crucial. In extreme cases, the radiused chamfer that provides lower drag resistance is recommended.</p>	<p>Now the capillary rises to loop height. In many machines, wire length is calculated so that enough wire feeds through the capillary to form the loop. While scratched wire is usually a result of the wire feed system, a polished hole may enhance the wire flow and reduce gold build-up.</p>	<p>The wire loop is formed as the machine moves the device in relation to the capillary. In more advanced and fast machines, the device remains stationary as the capillary is moved by the machine's bonding head. More sophisticated capillary trajectories can ensure that the wire stop entering or exiting the capillary.</p>	<p>The capillary stops, squashing the wire and forming the second bond. The ultrasonic vibration transmitted through the capillary is delivered by the tip surface to the bond. At this stage, best results are achieved by using a matt-finished surface.</p>	<p>The capillary rises to a position that leaves a calculated tail length. The tail must be long enough to prevent a ball from forming in the chamfer and weakening the 'neck' area.</p>

THE BONDING CYCLE

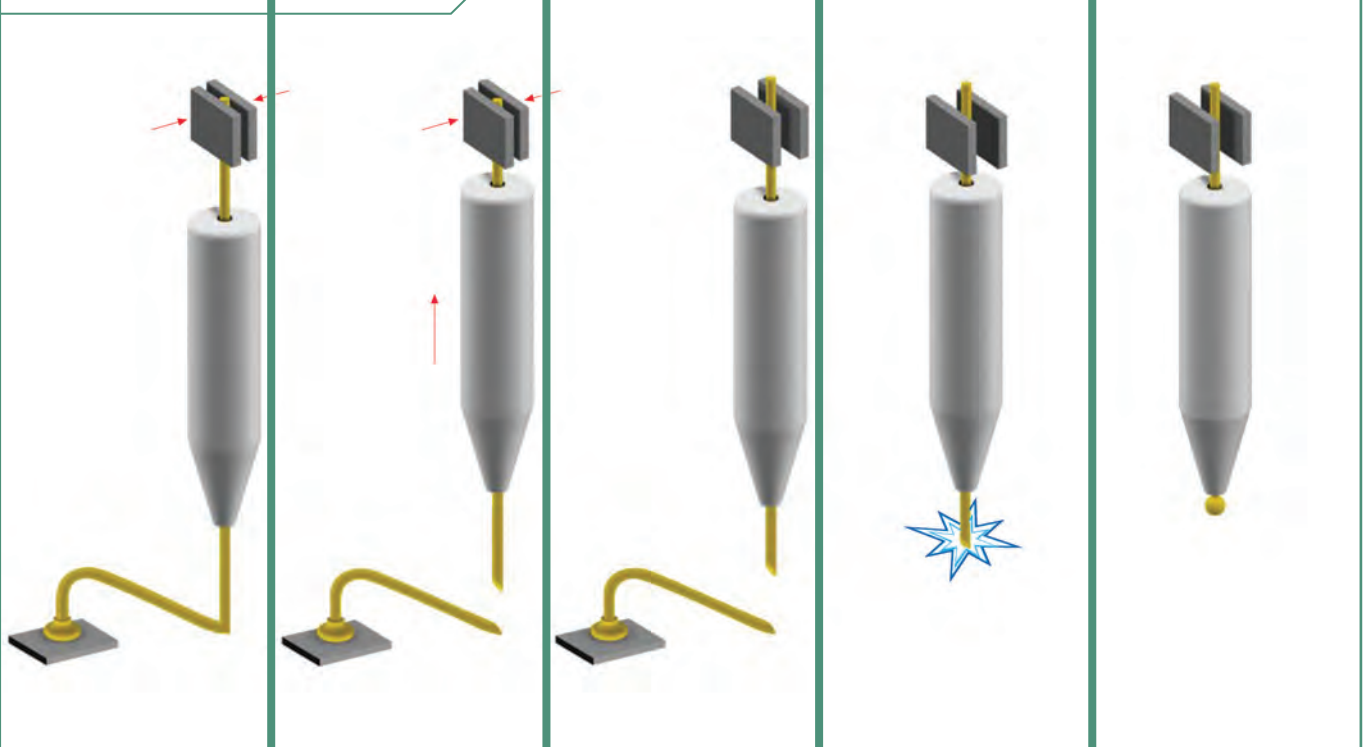

STAGE 9

Clamps closed and hold the wire, ready to tear it from the second bond. Exaggerated force or impact at the second bond may cut the wire during bond creation, resulting in 'no ball' stoppage. Parameters should be set so that only the clamps will tear the wire.

STAGE 10

As the capillary continues up, the wire tears at its weakest point – under the sharp edge of the chamfer – which serves as access concentration line.

STAGE 11

The capillary rises to 'reset height', leaving a tail of wire hanging under the hole.

STAGE 12

The EFO (Electronic Flame Off) wand approaches an electrical spark which melts the end of the wire.

STAGE 13

The wand retracts to its initial position, and the drop of melted wire solidifies in the form of a ball. The 'free-air-ball's' diameter is basically a result of the amount of energy created by the EFO and the tail length.

THE LONGER LIFESPAN CAPILLARY

Along with the semiconductor industry requirement of low machine downtime and high production throughput, Dou Yee capillaries offer maximum touchdowns with reduced tool change needs and achieving bond quality meeting industrial specifications. Other factors such as purity of the material substrates used, plating quality, its levelness and uniformity, bonding temperature, rigidity of the clamping system, will greatly affect capillary tool life.

At the initial R&D stage, Dou Yee material scientists have developed and recognized that Toughend Alumina (Pure Alumina doped with Zirconia plus additives) will be the future material for capillary. Recognizing this fact, Dou Yee only dedicates Toughened Alumina material to our customers whether it is for standard or fine-pitch capillaries.

Toughened Alumina itself presents many advantages over the standard Pure Alumina materials. At higher density, the material surface is non porous and chemical resistant. The smaller grain size makes the ceramic material finishing smoother. The sleek internal bore surface not only provides reduced wire drag which further enhance looping control, it is also instrumental in reducing the gold build-up rate. This has vast consequences resulting in longer lifespan of Dou Yee capillary.

TOUGHENED ALUMINA

Density
4.3g/cm³

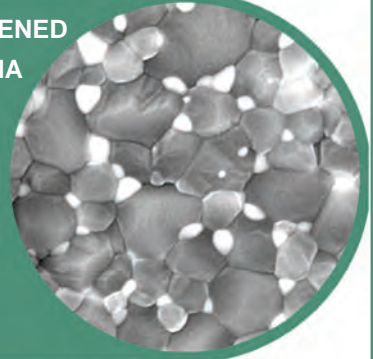

COMPETITOR PURE ALUMINA

Density
3.8g/cm³

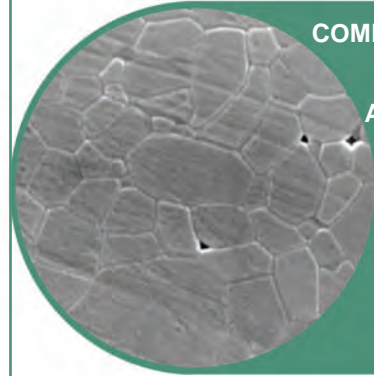

INTERNAL BORE SURFACE POLISHING

DOU YEE

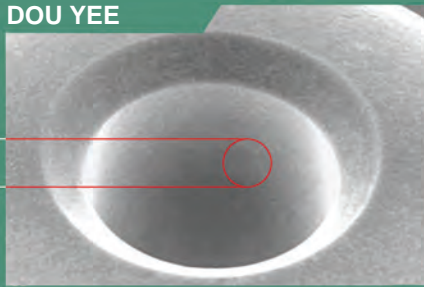

Smooth

COMPETITOR

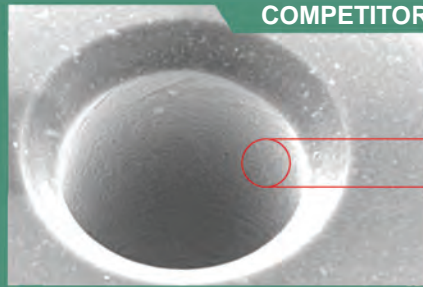

Rough

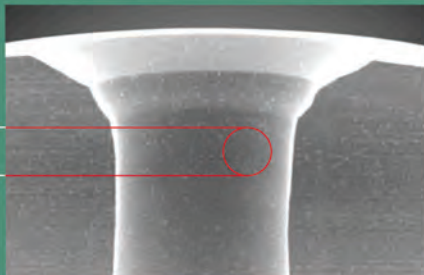

Smooth

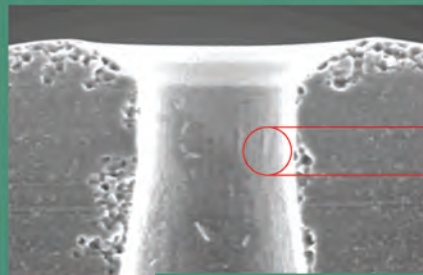

Rough

Toughened Alumina maximized the energy transfer from the transducer to the capillary. Engineers can set at a lower US power and/ or time on the wire bonders and yet achieving the same desired outputs. Toughened Alumina provides robust wire bonding operating windows. Gold build-up rate slows, resulting in the longer lifespan of Dou Yee capillary.

THE LONGER LIFESPAN CAPILLARY

Graphs demonstrating the efficient energy transfer and robust wire bonding windows of Dou Yee's Toughened Alumina capillaries.

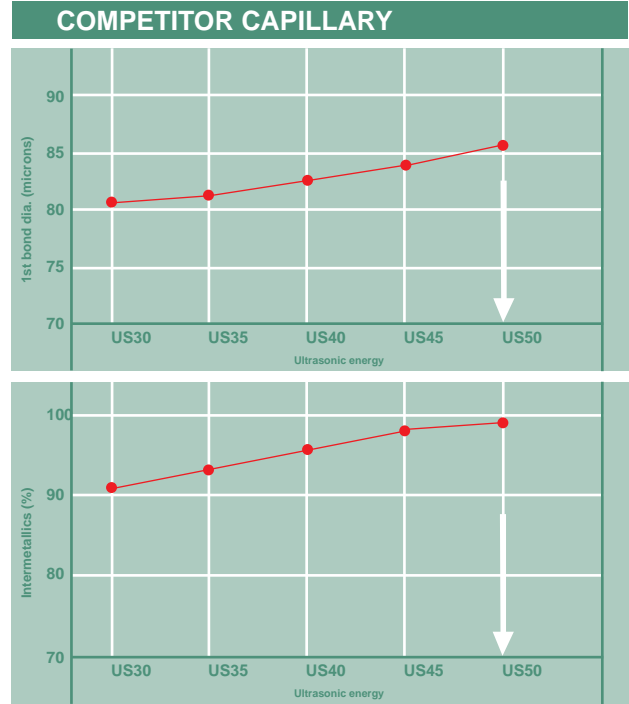
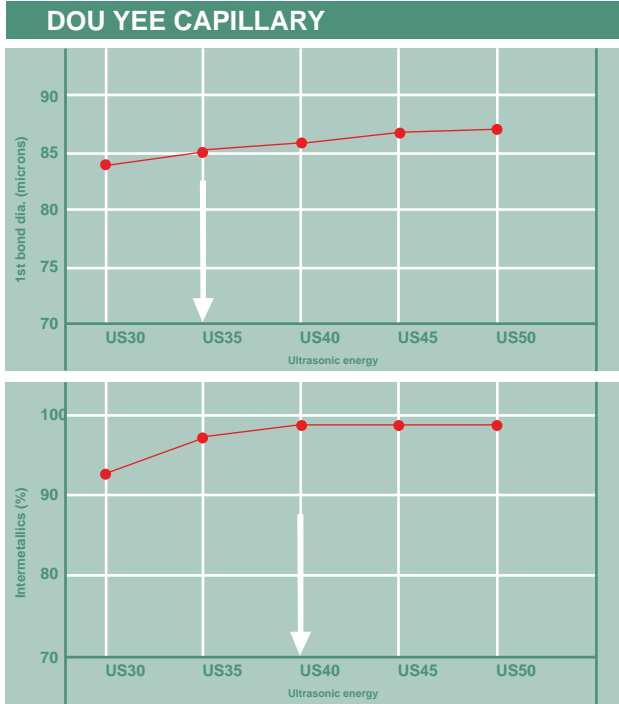

—●— Average

EXTENDING YOUR TOUCHDOWNS - THE LONGER LIFESPAN CAPILLARY

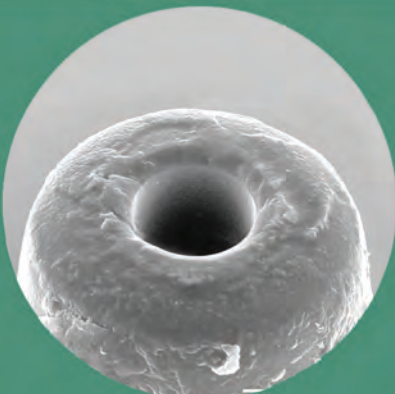

After 2.5 million bonds



After clean (gold removed)

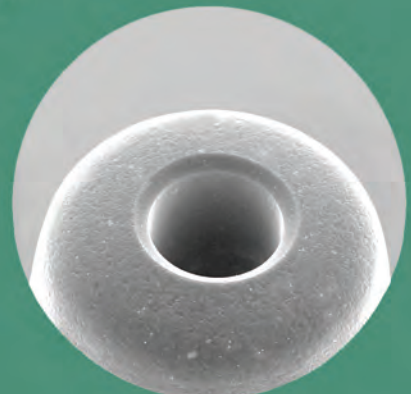

New Capillary

After 2.5 million touchdowns, Dou Yee's longer lifespan capillary (after clean) is comparable to a brand new capillary - a testimony to the excellent Toughened Alumina material.

HMX CAPILLARY



The new HMX Capillary developed by Dou Yee intend to satisfy the growing need for:

- (1) copper wire bonding;
- (2) challenging leadframes such as hard NiPd plated leadframes, QFN packages

Common problem associated with copper wire bonding and bonding on NiPd plated leadframes and QFN packages are poor bondability on the 2nd bond.

Dou Yee has developed the HMX Capillary with the objective to improve the bondability of the stitch bond through better coupling between the capillary and the wire during bonding. Its HMX proprietary process, not only result in rough surface, but also surface hardening and high wear resistance, thereby making it a long life capillary. Hence, the HMX capillary will not only deliver enhanced stitch bonding but also ball bondability, looping performance, improving machine utilisation, higher MTBA and higher throughput.

HMX Capillary Tip Texture
Finishing

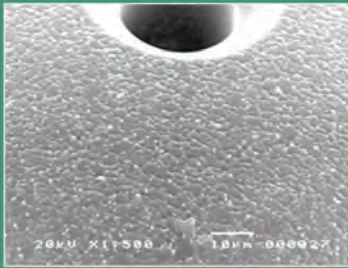

Conventional Capillary
Polish Finishing

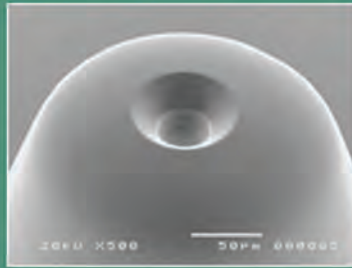

Matt Finishing

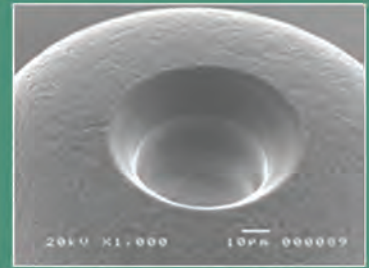

Bonding response with HMX Capillary for copper wire

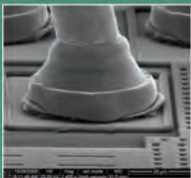

Ball Profile

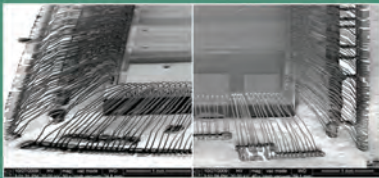

Looping Profile

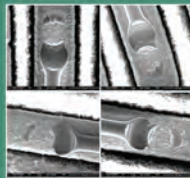

Stitch Profile

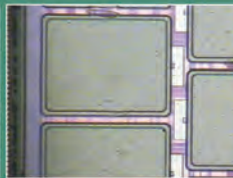

Cratering Test



Peel Test

HMX Capillary on NiPd Leadframe

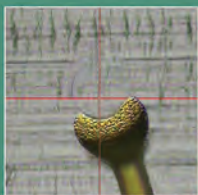

Stitch Bond

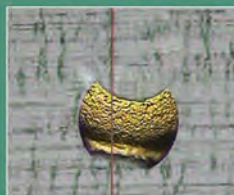

Peel Test

Conventional Capillary on NiPd Leadframe

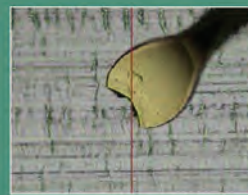

Stitch Bond

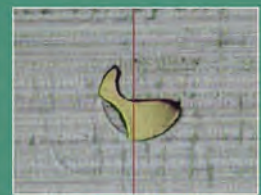

Peel Test



HMX Capillary (1.0m Bonds, After Wash)
(Tip still in good condition)
(Copper Wire Bonding)

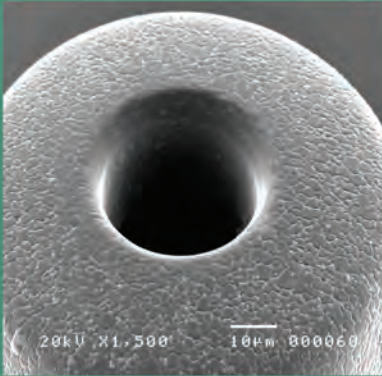

Competitor Capillary
(Serious tip wear observed)
(Copper Wire Bonding)

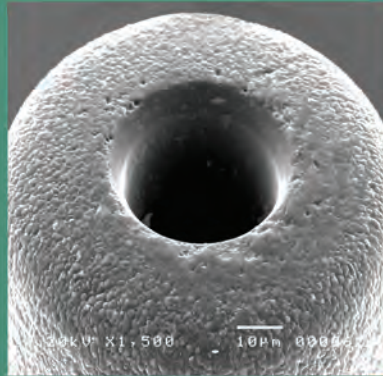

Features of HMX Capillary

- Improved and better mechanical coupling/ clamping *“inter-locking grip”* **F1** between capillary tip and the wire
- **Reduce displacement** between capillary tip and the wire **F1**
- **Maximum effective transfer of ultrasonic energy** to the wire (frictional factor increases, creates stronger/ inter-metallic weld) **F2**
- **Increased in contact surface areas** between capillary and the wire

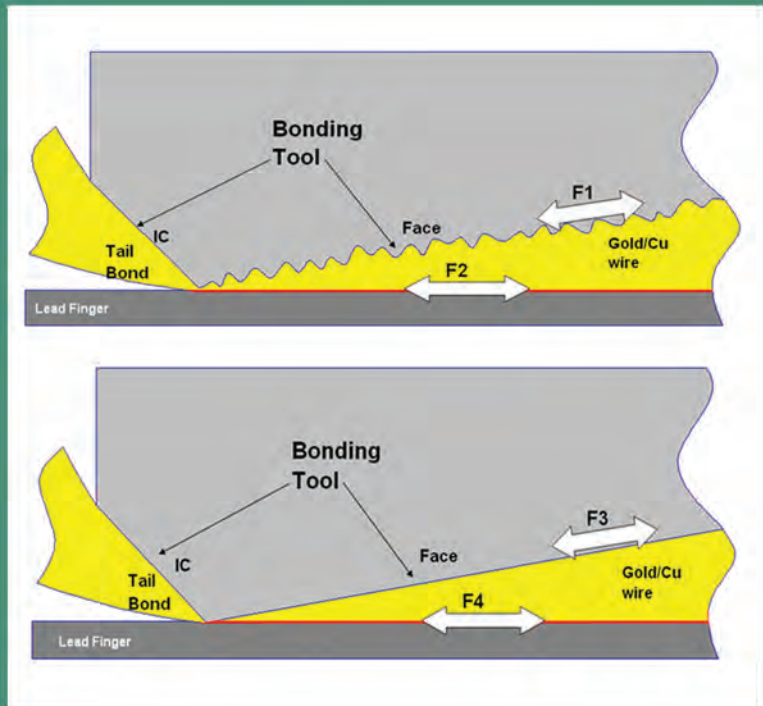

RUBY CAPILLARY

Super Long Life Capillary

With high U.S. energy transfer (>85%); high wear resistance; high bending strength; and low frictional co-efficient, hence low contamination build-up; Dou Yee Ruby capillary delivers super long life bonding. It is also suitable for re-cycling due to its high acid resistance.



Minimal Contamination Build-Up after 3.5 KK Bonds

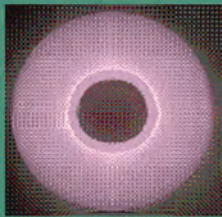

0 KK

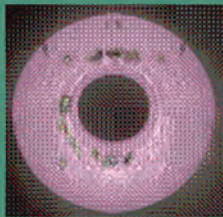

1 KK

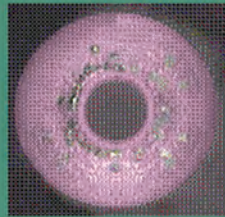

2 KK

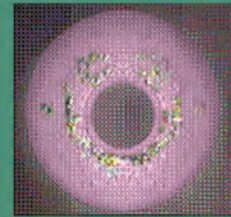

3.5 KK

Bonding Response

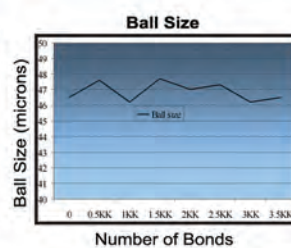
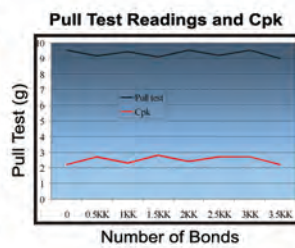
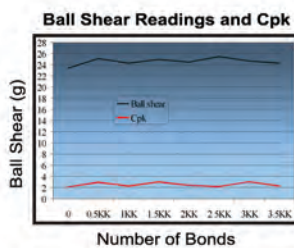
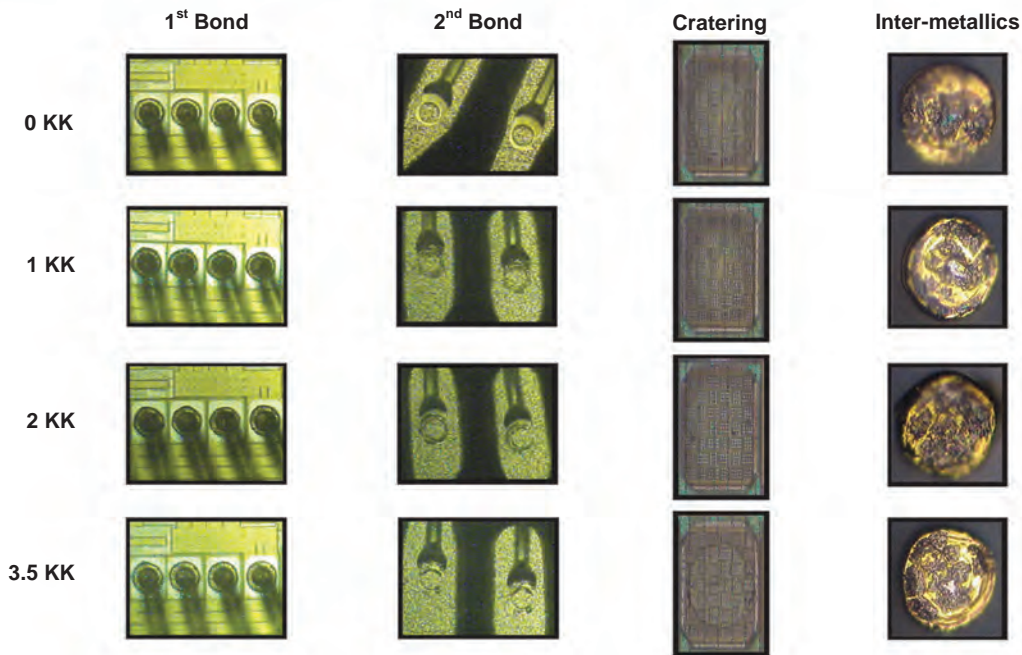

CAPILLARY MANUFACTURING PROCESS

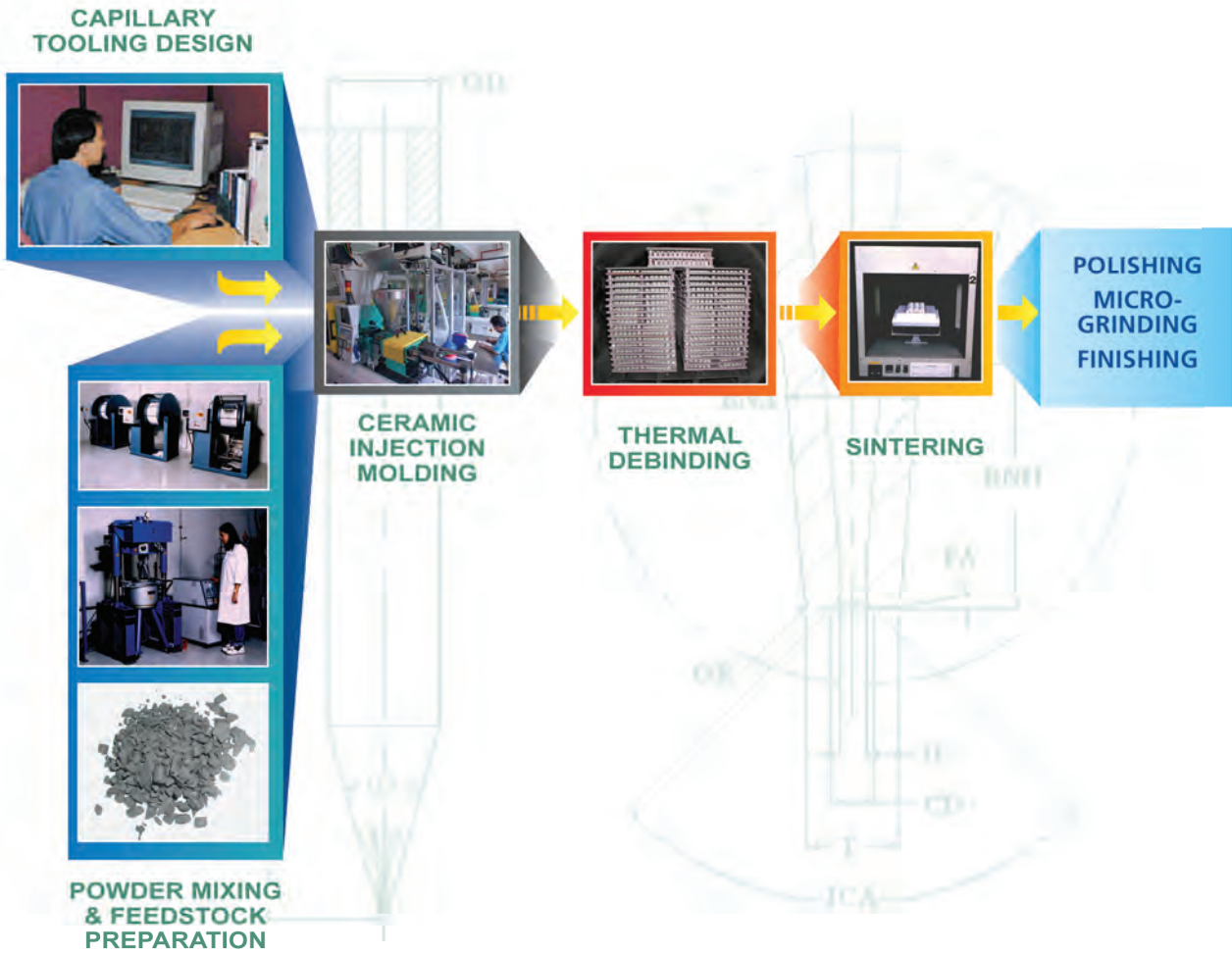

Starting from ultra-fine powders, Dou Yee capillaries are manufactured using state-of-the-art Ceramic Injection Molding technology.

Besides allowing miniature and intricate parts like capillaries' blanks to be produced in high production rates and at low manufacturing costs, Ceramic Injection Molding process offers a high degree of repeatability and reproducibility with tight tolerances.

Further operations of polishing, micro-grinding and finishing completes and customizes the capillary to suit each individual customer's application needs.

QUALITY ASSURANCE/ INSPECTION SYSTEM

Operating at the highest quality standard with documented quality control system, Dou Yee capillary is subjected to 100% quality inspection at all capillary production stages. Dou Yee is committed to build and dedicated to deliver only superior quality capillary to our esteemed customers.

State of the Art Image Measurement System

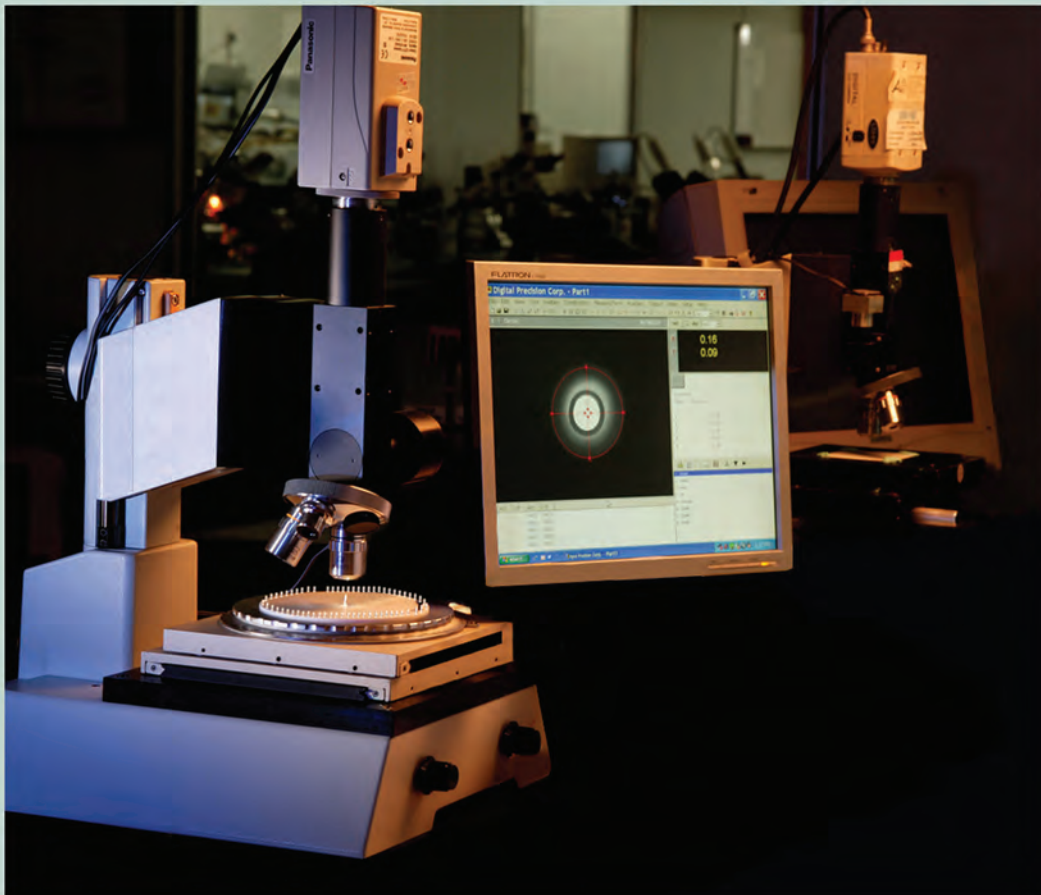

ISO 9001: 2008



ISO 13485: 2003



ISO 9001: 2008



CAPILLARY FEATURES

Chamfer Ball Control (CBC) Design Capillaries for Ultra-Fine Pitch Bondings

CBC design capillaries are recommended for ball bond diameters below 60 microns.

The concept of the CBC design is to have a more acute Inner Chamfer Angle (ICA) to contain squashed Free Air Ball (FAB) during bonding process. With the increase in volume in the ICA (see figure 1) and the direction bond force F_2 (see figure 2) is more inward than conventional larger ICAs, the result is less deformation under the capillary face, giving a smaller mashed ball diameter and better bond placement. This is very important for ultra-fine pitch application with small bond size.

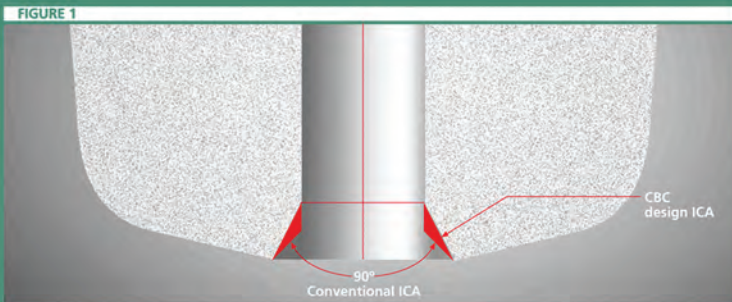

The CBC design improves the transfer of Bond Power (USG) during ball bond process through bigger surface area contact with the deformed FAB during the bonding process, thus resulting in the higher inter-metallic coverage compared to a conventional ICA profile. Consequently CBC design results in higher shear strength over the conventional ICA design.

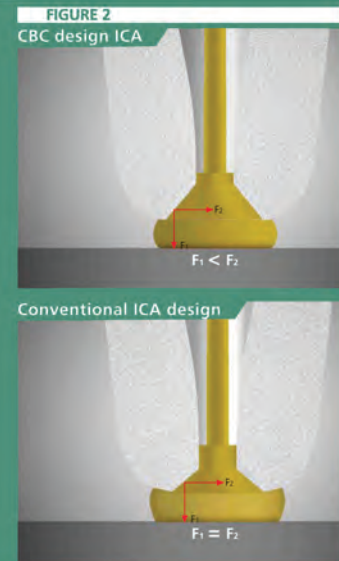

TAIL BOND ENHANCER

Matrix Package (QFN / TFBGA SERIES)

Matrix lead frame are typically pre-laminated with polymer film. This causes unacceptable lead frame coplanarity and the softening of the polymer film when heated creates a bouncing/floating effect so that it is difficult to achieve reliable and stable stitch bonds.

A special capillary internal chamfer design has been developed to lessen the leads bouncing effect during the lead bonds which lead to short tail or EFO open (no Free Air Ball formed). This feature, called Tail Bond Enhancer (TBE), helps reduce the wire tail 'premature termination' during the initial contact to form the second bond. It reinforces the tail bond strength, thus minimizing the short tail or EFO open (no FAB formed)

CAPILLARY WITH TBE FEATURE



SPECIAL BONDINGS

Stud Gold Ball Bump Capillary

Stud Bonding

FIGURE 1 : Schematic of stud bond using software modification on ball / wedge bonding machine

Gold/Copper Stud Bumping



Capillary descends to bond the ball bond on the pad of device

Capillary raises to clear ball, offset (+ or -) to descend (coining)

Capillary descends to coin the ball bond

Capillary rises to tear off to form tail.

Stub bond completed. EFO fire to form FAB for the next bond

This technique is a mechanical single point bumping technology that is derived from the conventional ball-wedge bumping process on the wire bonder with modified bond control software.

The guideline for stud bonding is the desired mashed ball diameter given the bond pad opening. The control factor for capillary design is the inner chamfer diameter, tip diameter and hole size.

Figure 2 gives an SEM image of a mechanically applied gold stud bump.

FIGURE 2
SEM image
of a
mechanically
applied
gold
stud bump



Bond Stitch On Ball (BSOB) Bonding

Bond stitch on ball (BSOB) bonding is vital when one needs to wedge bond on active circuitry. The stud / bump acts as a conductive barrier and prevents the capillary coming in contact on the active circuitry and damage it.

BSOB bonding is also recommended in applications where very short deep and low loop lengths or enhanced wedge bond strength on poor bondability substrate surface. The process is divided into two step or cycles. The first cycle is to bond the stud bonding called bump onto the bond pad, followed by the reverse bonding where the ball bond is placed on the lead or adjacent die pad (for die-to-die connection) and stitch bond it on the ball bump.



CAPILLARY DESIGN RULES

Terminology and Definitions

1. Bond Pad Pitch (BPP) is defined as distance between the centers of two adjacent pads.
2. Bond Pad Opening (BPO) is defined as the bonding area where the mashed ball is being bonded. This area excludes the passivated area of the bond pad.
3. Critical loop height (CLH) is defined as the height of the loop that is in the same vertical plane of the capillary viewing from the side. As once the capillary passes this plane, whatever its loop height, the wire will not touch the adjacent capillary.

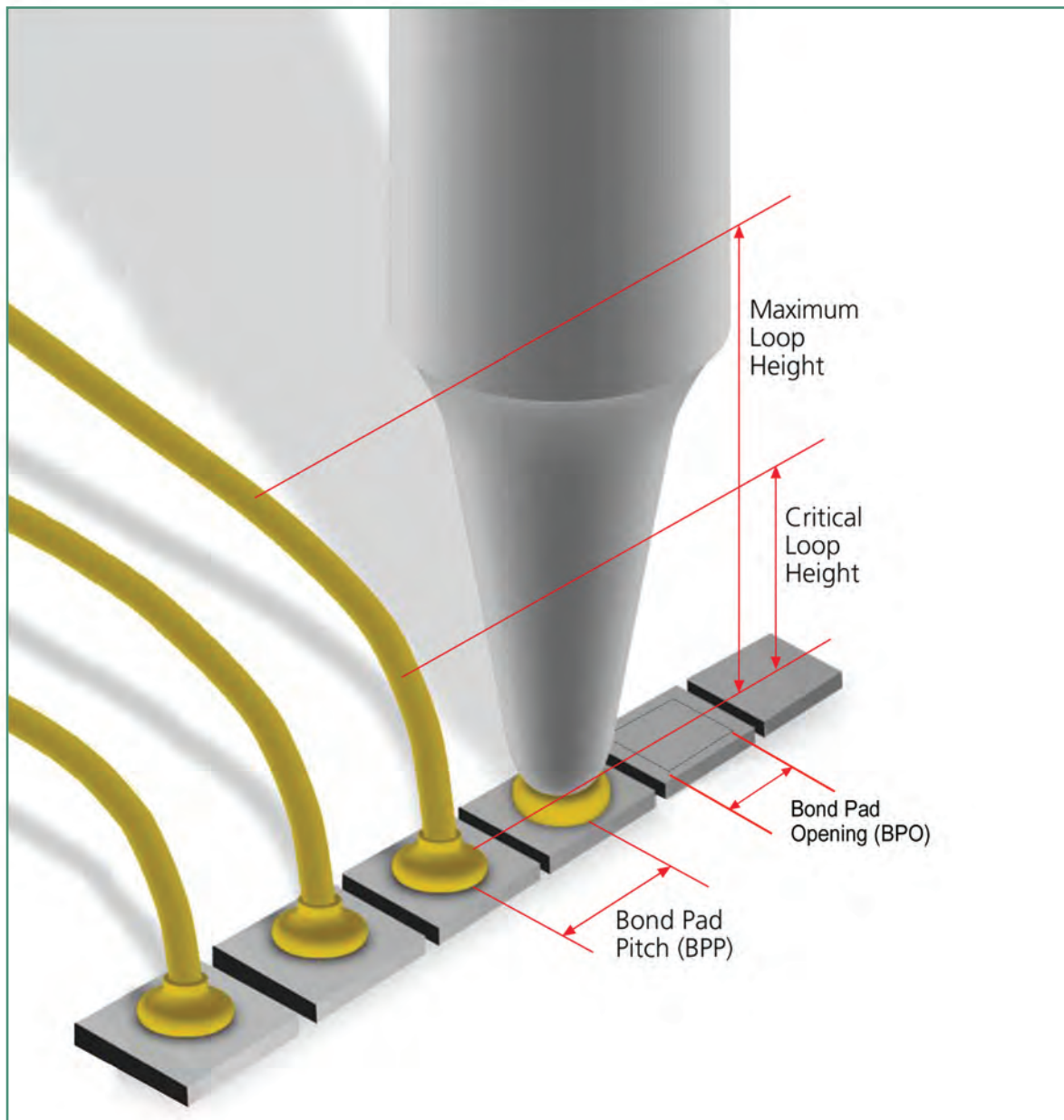

CAPILLARY DESIGN RULES

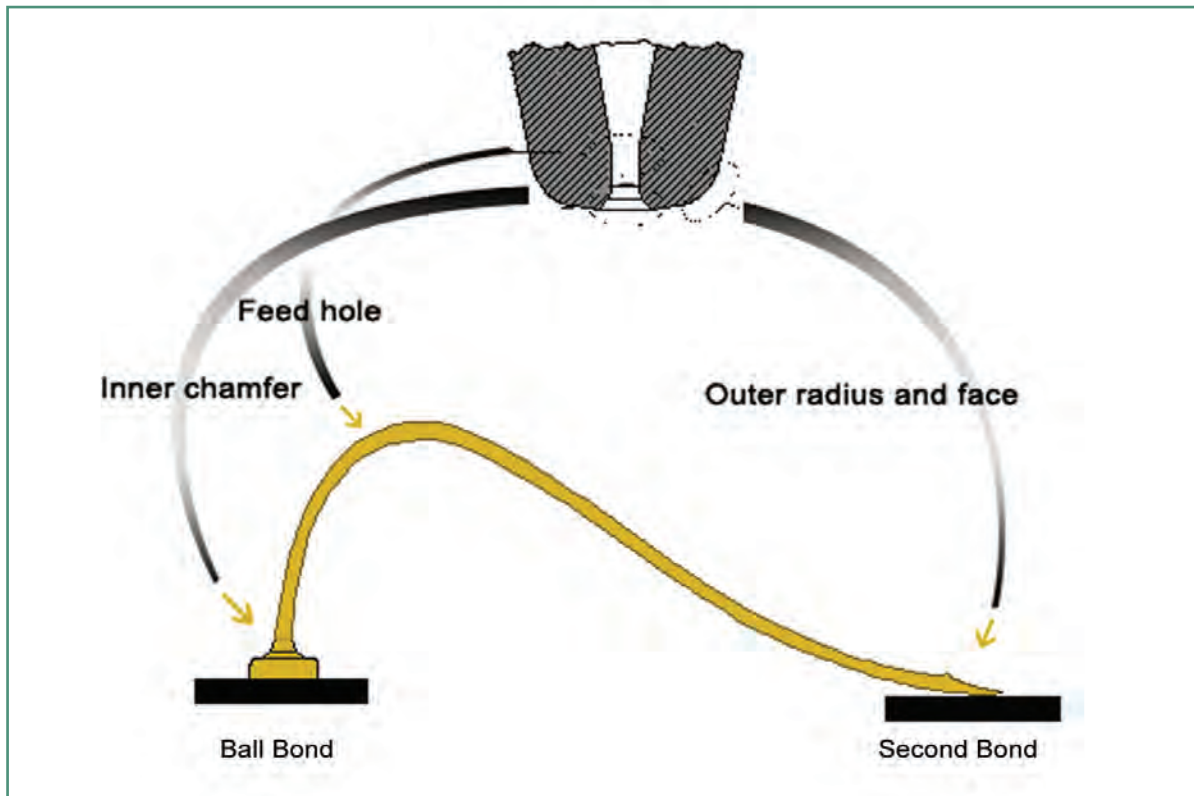

(A) Capillary Parameters Affecting Ball Bond

1. Hole Diameter (H)

- is determined based on Wire Diameter (WD)
- the relationship between Hole and Wire Diameter will affect ball size, ball neck formation, looping, wire drag and wire damage

2. Chamfer Diameter (CD)

- the main function of the CD is to capture and center the Free Air Ball (FAB) before the ball bond
- the diameter, thickness of the ball bond will mainly depend on the size of CD and FAB

3. Inner Chamfer Angle (ICA)

- grips the FAB and provides certain amount of squashed out in the formation of ball bond
- affect tail bond
- 120° ICA provides maximum downward force vector/ reduces stitch cut at second bond and stronger tail bond
- 90° ICA provides equal downward force vector/ more compact ball bond
- CBC design provides maximum free air ball capture, more inward force vector, provides better ball size control

(B) Capillary Parameters Affecting Stitch Bond

1. Tip Diameter (T)
 - providing the stitch pull strength; the larger the tip diameter, the larger surface will be provided for second bonding; hence higher stitch pull strength

2. Face Angle (FA)
 - determines the shape, width, and thickness of the stitch bond

3. Outer Radius (OR)
 - is also a main factor to determine the shape, width, and thickness of stitch bond
 - creates smooth transition between FA and CA to avoid heel crack

4. Tip Finishing
 - Polish Finish is used for very good bondability application, provides longer tool life, and less prone to build-up
 - Matt Finish provides maximum coupling between capillary tip surface and wire, thus giving maximum ultrasonic energy transferred, may be prone to more build-up than polish tip
 - HMX Finish, our newly developed tip finishing specially catered for copper wire bonding, hard leadframe such as NiPd and QFN packages

(C) Capillary Parameters Affecting Looping

1. Hole, Inner Chamfer Angle, Outer Radius

Though the wire bonder looping software is a key factor affecting looping, capillary parameters such as Hole, Inner Chamfer, and Outer Radius also play a critical role in looping control.

CAPILLARY PARAMETER SELECTION GUIDE

Capillary Hole Diameter (H)

Top View of Capillary Hole Diameter

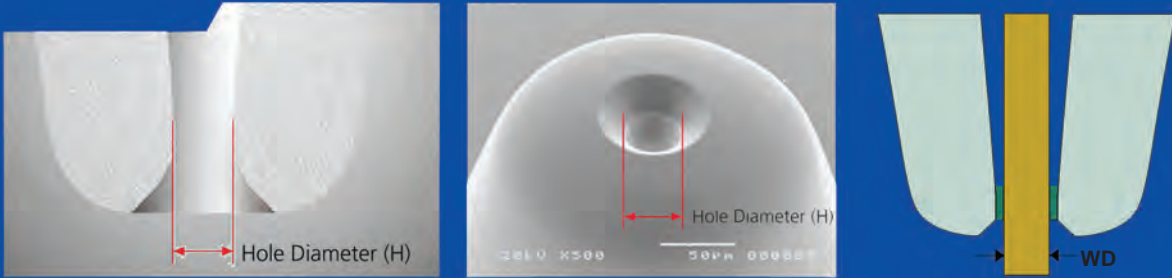

HOLE SELECTION FOR STANDARD & FINE PITCH CAPILLARY

Bond Pad Pitch (μm)	Wire Diameter		Recommended Hole		Min. Recommended Hole	
	mil	μm	mil	μm	mil	μm
> 100	3.0	76	4.0	102	3.8	97
	2.5	64	3.4	86	3.1	79
	2.0	51	2.6	66	2.5	64
	1.5	38	2.0	51	1.9	48
	1.3	33	1.7	43	1.6	41
	1.2	30	1.6	41	1.5	38
	1.0	25	1.4	36	1.3	33
70 to 100	1.3	33	1.7	43	1.6	41
	1.2	30	1.6	41	1.5	38
	1.0	25	1.4	36	1.3	33
	0.8	20	1.1	28	1.0	25
60	1.0	25	1.3	33	1.25	32
	0.90	23	1.20	30	1.15	29
	0.80	20	1.10	28	1.05	27

HOLE SELECTION FOR ULTRA FINE PITCH CAPILLARY

Bond Pad Pitch (μm)	Wire Diameter		Recommended Hole		Min. Recommended Hole	
	mil	μm	mil	μm	mil	μm
55	0.90	23	1.20	30	1.15	29
50	0.80	20	1.10	28	1.05	27
45	0.70	18	0.95	24	0.90	23

CAPILLARY PARAMETER SELECTION GUIDE

Capillary Chamfer Diameter (CD)

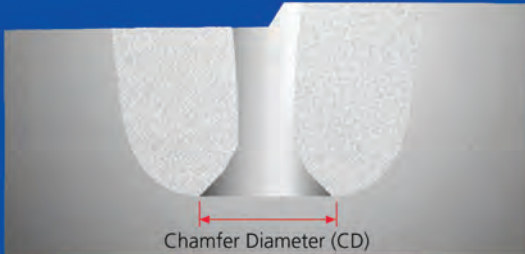

Capillary Inner Chamfer Angle (ICA)

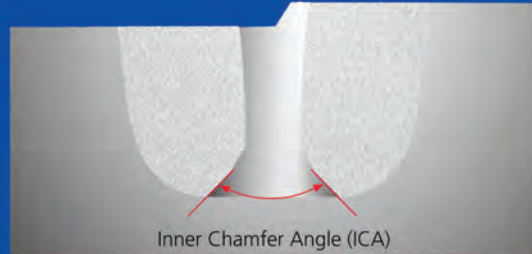

TYPICAL CAPILLARY CHAMFER DIAMETER CORRESPOND TO AVERAGE FIRST BOND DIAMETER

Chamfer Diameter	Average First Bond Diameter
mil / μm	mil / μm
1.4 / 35	1.6 - 1.8 / 41 - 46
	CBC design
1.6 / 41	1.8 - 2.0 / 46 - 51
	CBC design
1.8 / 46	2.0 - 2.2 / 51 - 56
2.0 / 51	2.2 - 2.4 / 56 - 61
2.2 / 56	2.5 - 2.8 / 64 - 71
2.4 / 61	2.6 - 2.9 / 66 - 74
2.6 / 66	2.9 - 3.2 / 74 - 80
2.8 / 71	3.1 - 3.4 / 78 - 86
3.0 / 76	3.4 - 3.7 / 86 - 95
3.2 / 81	3.6 - 3.9 / 91 - 100
3.4 / 86	3.8 - 4.2 / 97 - 105
3.6 / 91	4.0 - 4.4 / 102 - 113
3.8 / 97	4.3 - 4.7 / 109 - 120
4.0 / 102	4.5 - 4.9 / 114 - 125
4.2 / 107	4.7 - 5.1 / 120 - 130
4.4 / 112	5.0 - 5.5 / 127 - 140
4.6 / 117	5.3 - 5.8 / 135 - 147
4.8 / 122	5.5 - 6.1 / 140 - 155
5.0 / 127	5.8 - 6.3 / 147 - 160

CAPILLARY PARAMETER SELECTION GUIDE

Capillary Tip Diameter (T)

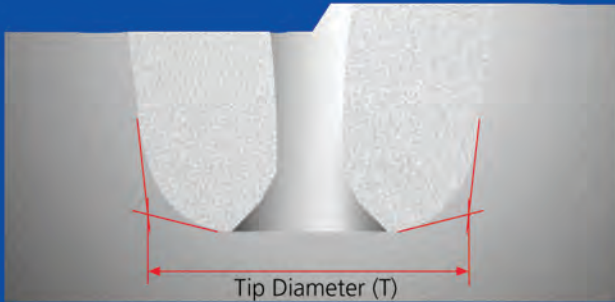

Stitch Bond

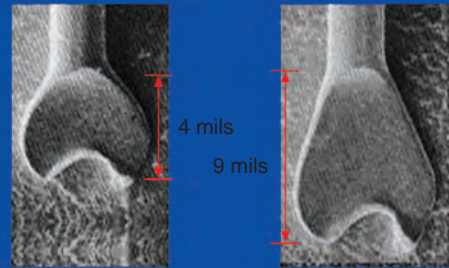

TYPICAL BOND PAD PITCH GUIDE

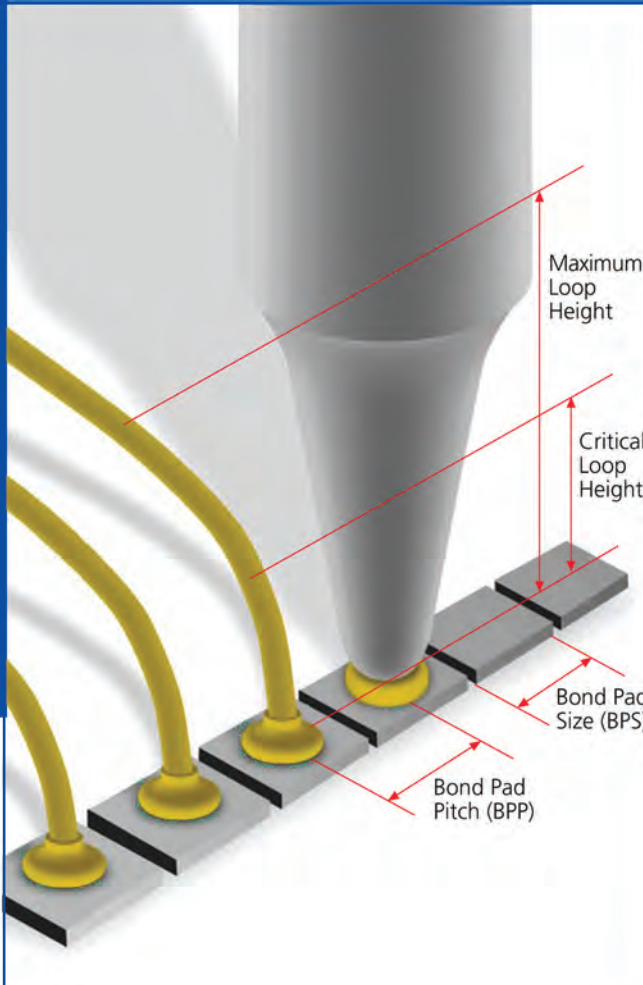

Pad Pitch (μm)	Tip Diameter mil (μm)	Recommended Bottleneck Height mil (μm)
100	5.2 - 5.5 (132 - 140)	8 - 20 (203 - 508)
90	4.2 - 4.5 (107 - 114)	8 - 15 (203 - 381)
80	3.9 - 4.1 (99 - 104)	8 - 10 (203 - 254)
70	3.6 - 3.8 (91 - 97)	8 - 10 (203 - 254)
60	3.1 - 3.3 (79 - 84)	6 - 8 (152 - 203)
50	(66 - 71)	4 - 6 (102 - 152)
45	(53 - 58)	4 - 6 (102 - 152)

CAPILLARY PARAMETER SELECTION GUIDE

Capillary Tip Finishing (P, M & HMX)



Capillary Face Angle (FA)



Dimensional Symbol	Determine Factor	Function
FA	2nd Bondability	Determines the shape, width and thickness of stitch bond
		FA 0° - Normally coupled with large OR for poor flatness or planarity surface.
		FA 4° - Poor bondability metalization
		FA 8° - Provide adequate downward force to avoid heel crack. Most commonly used design.
		FA 11° - For soft surface metalization. - Recommended for fine pitch capillaries

CAPILLARY PARAMETER SELECTION GUIDE

Capillary Outer Radius (OR)

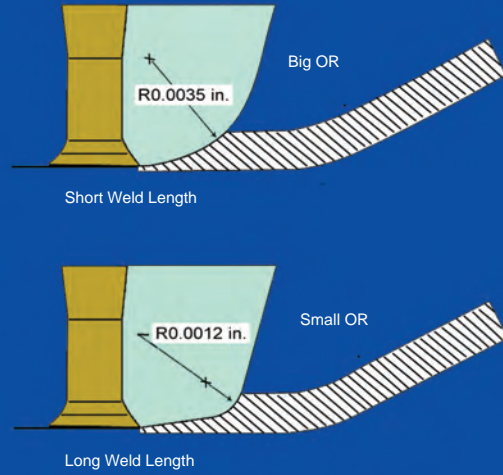
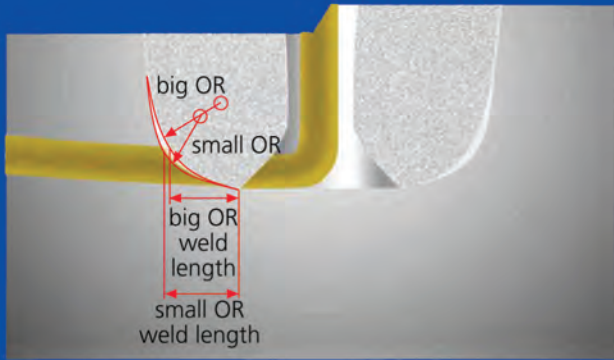

CAPILLARY OUTER RADIUS VERSUS TIP DIAMETER SELECTION GUIDE

Tip Diameter in mil/ μm	Outer Radius in mil/ μm	Capillary Design
2.8 / 71	0.4 / 10	Bottleneck Capillary
3.0 / 76	0.5 / 12	
3.1 / 79	0.5 / 12	
3.5 / 89	0.5 / 12	
3.9 / 99	0.5 / 12	
4.3 / 109	0.8 / 20	
4.7 / 119	0.8 / 20	
5.1 / 130	1.2 / 30	
5.5 / 140	1.2 / 30	
5.9 / 150	1.2 / 30	
6.5 / 165	1.5 / 38	
7.1 / 180	1.5 / 38	
7.9 / 200	2.0 / 51	
8.9 / 226	2.0 / 51	
9.8 / 249	2.0 / 51	
11.8 / 300	2.5 / 64	

STANDARD CAPILLARY DIMENSIONS TABLE

Wire Diameter mil / μm	Average 1st Bond Diameter mil / μm	T Tip Diameter mil / μm	H Hole Diameter mil / μm	CD Chamfer Diameter mil / μm	FA Face Angle degree	OR Outer Radius mil / μm
0.8 - 0.9 / 20 - 22	2.1 / 53	5.1 / 130	1.2 / 30	1.8 / 46	4° 8° 11°	0.8 / 20
0.8 - 0.9 / 20 - 22	2.3 / 58	5.1 / 130	1.3 / 33	2.0 / 51	4° 8° 11°	1.0 / 25
0.9 - 1.0 / 22 - 25	2.3 / 58	5.5 / 140	1.3 / 33	2.0 / 51	4° 8° 11°	1.0 / 25
0.9 - 1.0 / 22 - 25	2.6 / 66	5.5 / 140	1.4 / 36	2.2 / 56	4° 8° 11°	1.0 / 25
1.0 - 1.1 / 25 - 28	2.3 / 58	5.5 / 140	1.4 / 36	2.0 / 51	4° 8° 11°	1.0 / 25
1.0 - 1.1 / 25 - 28	2.6 / 66	5.5 / 140	1.5 / 38	2.2 / 56	4° 8° 11°	1.0 / 25
1.0 - 1.1 / 25 - 28	2.4 / 61	6.0 / 152	1.4 / 36	2.1 / 53	4° 8° 11°	1.2 / 30
1.0 - 1.1 / 25 - 28	2.7 / 69	6.0 / 152	1.5 / 38	2.3 / 58	4° 8° 11°	1.5 / 38
1.0 - 1.1 / 25 - 28	2.4 / 61	6.5 / 165	1.4 / 36	2.1 / 53	0° 4° 8° 11°	1.5 / 38
1.0 - 1.1 / 25 - 28	2.7 / 69	6.5 / 165	1.5 / 38	2.3 / 58	0° 4° 8° 11°	1.5 / 38
1.0 - 1.1 / 25 - 28	3.1 / 79	6.5 / 165	1.5 / 38	2.7 / 69	0° 4° 8° 11°	1.5 / 38
1.2 - 1.3 / 30 - 33	3.1 / 79	6.5 / 165	1.7 / 43	2.7 / 69	0° 4° 8° 11°	1.5 / 38
1.0 - 1.1 / 25 - 28	2.7 / 69	7.1 / 180	1.4 / 36	2.3 / 58	0° 4° 8° 11°	1.5 / 38
1.0 - 1.1 / 25 - 28	3.1 / 79	7.1 / 180	1.5 / 38	2.7 / 69	0° 4° 8° 11°	1.5 / 38
1.0 - 1.1 / 25 - 28	3.1 / 79	7.1 / 180	1.5 / 38	2.7 / 69	0° 4° 8° 11°	1.5 / 38
1.2 - 1.3 / 30 - 33	3.3 / 84	7.1 / 180	1.7 / 43	2.9 / 74	0° 4° 8° 11°	1.5 / 38
1.2 - 1.3 / 30 - 33	3.5 / 89	7.1 / 180	1.8 / 46	3.0 / 76	0° 4° 8° 11°	1.5 / 38
1.2 - 1.3 / 30 - 33	3.3 / 84	8.0 / 203	1.5 / 38	2.9 / 74	0° 4° 8° 11°	1.5 / 38
1.2 - 1.3 / 30 - 33	3.3 / 84	8.0 / 203	1.8 / 46	2.7 / 74	0° 4° 8° 11°	2.0 / 51
1.2 - 1.3 / 30 - 33	3.5 / 89	8.0 / 203	1.8 / 46	3.0 / 76	0° 4° 8° 11°	2.0 / 51
1.2 - 1.3 / 30 - 33	3.5 / 89	8.8 / 224	1.8 / 46	3.0 / 76	0° 4° 8° 11°	2.0 / 51
1.5 / 38	3.7 / 94	8.8 / 224	2.0 / 51	3.1 / 79	0° 4° 8° 11°	2.0 / 51
1.5 / 38	3.9 / 99	8.8 / 224	2.0 / 51	3.3 / 84	0° 4° 8° 11°	2.0 / 51
2.0 / 51	6.0 / 152	11.8 / 300	2.5 / 64	5.0 / 127	0° 4° 8° 11°	2.5 / 64
2.0 / 51	6.0 / 152	11.8 / 300	2.7 / 69	5.0 / 127	0° 4° 8° 11°	2.5 / 64
2.0 / 51	6.0 / 152	14.0 / 356	2.7 / 69	5.0 / 127	0° 4° 8° 11°	3.0 / 76
2.0 / 51	6.0 / 152	14.0 / 356	3.0 / 76	5.0 / 127	0° 4° 8° 11°	3.0 / 76
2.5 / 64	6.6 / 168	14.0 / 356	3.4 / 86	5.5 / 140	0° 4° 8° 11°	3.0 / 76
3.0 / 76	6.6 / 168	16.5 / 419	4.0 / 102	5.5 / 140	0° 4° 8° 11°	3.0 / 76
3.0 / 76	7.0 / 178	16.5 / 419	4.0 / 102	5.8 / 147	0° 4° 8° 11°	3.0 / 76

FINE PITCH CAPILLARY DIMENSIONS FOR 60µm B.P.P AND ABOVE TABLE

Bond Pad Pitch (B.P.P) mil / µm	Wire Diameter mil / µm	Average 1st Bond Diameter mil / µm	T Tip Diameter mil / µm	H Hole Diameter mil / µm	CD Chamfer Diameter mil / µm	FA Face Angle degree	OR Outer Radius mil / µm	BTNK Height mil / µm
2.4 / 60	0.9 / 23	1.8 / 45	3.3 / 84	1.2 / 30	1.6 / 41	11°	0.5 / 13	8 / 203
2.4 / 60	0.9 / 23	1.7 / 43	3.3 / 84	1.2 / 30	1.5 / 38	11°	0.5 / 13	8 / 203
2.4 / 60	0.8 / 20	1.8 / 45	3.3 / 84	1.1 / 28	1.6 / 41	11°	0.5 / 13	8 / 203
2.4 / 60	0.8 / 20	1.7 / 43	3.3 / 84	1.1 / 28	1.5 / 38	11°	0.5 / 13	8 / 203
2.4 / 60	0.8 / 20	1.6 / 41	3.3 / 84	1.1 / 28	1.4 / 36	11°	0.5 / 13	8 / 203
2.8 / 70	0.8 - 0.9 / 20 - 22	1.9 / 48	3.7 / 94	1.2 / 30	1.7 / 43	8° 11°	0.5 / 13	8 / 203
2.8 / 70	1.0 / 25	1.9 / 48	3.7 / 94	1.3 / 33	1.7 / 43	8° 11°	0.5 / 13	8 / 203
2.8 / 70	1.0 / 25	2.1 / 53	3.7 / 94	1.3 / 33	1.9 / 48	8° 11°	0.5 / 13	8 / 203
3.1 / 80	1.0 / 25	2.0 / 51	4.0 / 102	1.3 / 33	1.8 / 46	8° 11°	0.8 / 20	10 / 254
3.1 / 80	1.0 / 25	2.2 / 56	4.0 / 102	1.3 / 33	2.0 / 51	8° 11°	0.8 / 20	10 / 254
3.1 / 80	1.2 - 1.3 / 30 - 33	2.3 / 58	4.0 / 102	1.6 / 41	2.1 / 53	8° 11°	0.8 / 20	10 / 254
3.5 / 90	0.8 - 0.9 / 20 - 22	2.1 / 53	4.3 / 110	1.3 / 33	1.8 / 46	8° 11°	1.0 / 25	10 / 254
3.5 / 90	0.8 - 0.9 / 20 - 22	2.3 / 58	4.3 / 110	1.3 / 33	2.0 / 51	8° 11°	1.0 / 25	10 / 254
3.5 / 90	1.0 - 1.1 / 25 - 28	2.5 / 64	4.3 / 110	1.4 / 36	2.2 / 56	8° 11°	1.0 / 25	10 / 254
3.5 / 90	1.0 - 1.1 / 25 - 28	2.7 / 69	4.3 / 110	1.4 / 36	2.4 / 61	8° 11°	1.0 / 25	10 / 254
3.5 / 90	1.2 - 1.3 / 30 - 33	2.6 / 66	4.3 / 110	1.6 / 41	2.3 / 58	8° 11°	1.0 / 25	10 / 254
3.5 / 90	1.2 - 1.3 / 30 - 33	2.9 / 74	4.3 / 110	1.6 / 41	2.5 / 64	8° 11°	1.0 / 25	10 / 254
3.9 / 100	0.9 - 1.0 / 22 - 25	2.1 / 53	5.2 / 132	1.3 / 33	1.9 / 48	8° 11°	1.0 / 25	11 / 279
3.9 / 100	1.0 - 1.1 / 25 - 28	2.3 / 58	5.2 / 132	1.4 / 36	2.0 / 51	8° 11°	1.0 / 25	11 / 279
3.9 / 100	1.0 - 1.1 / 25 - 28	2.7 / 69	5.2 / 132	1.5 / 38	2.3 / 58	8° 11°	1.0 / 25	11 / 279
3.9 / 100	1.1 - 1.2 / 28 - 30	2.9 / 74	5.2 / 132	1.6 / 41	2.5 / 64	8° 11°	1.0 / 25	11 / 279
3.9 / 100	1.2 - 1.3 / 30 - 33	2.9 / 74	5.2 / 132	1.7 / 43	2.5 / 64	8° 11°	1.0 / 25	11 / 279
4.3 / 110	1.0 - 1.1 / 25 - 28	2.7 / 69	6.0 / 152	1.4 / 36	2.3 / 58	8° 11°	1.2 / 30	12 / 305
4.3 / 110	1.0 - 1.1 / 25 - 28	2.9 / 74	6.0 / 152	1.5 / 38	2.5 / 64	8° 11°	1.2 / 30	12 / 305
4.3 / 110	1.2 - 1.3 / 30 - 33	3.0 / 76	6.0 / 152	1.7 / 43	2.6 / 66	8° 11°	1.2 / 30	12 / 305
4.7 / 120	1.0 - 1.1 / 25 - 28	2.7 / 69	6.5 / 165	1.4 / 36	2.3 / 58	8° 11°	1.5 / 38	12 / 305
4.7 / 120	1.0 - 1.1 / 25 - 28	2.9 / 74	6.5 / 165	1.5 / 38	2.5 / 64	8° 11°	1.5 / 38	12 / 305
4.7 / 120	1.2 - 1.3 / 30 - 33	3.0 / 76	6.5 / 165	1.7 / 43	2.6 / 66	8° 11°	1.5 / 38	12 / 305

ULTRA-FINE PITCH CAPILLARY (CBC DESIGN) DIMENSIONS FOR 55 μ m B.P.P AND BELOW TABLE

Bond Pad Pitch (B.P.P) mil / μ m	Wire Diameter mil / μ m	Average 1st Bond Diameter mil / μ m	T Tip Diameter mil / μ m	H Hole Diameter mil / μ m	CD Chamfer Diameter mil / μ m	FA Face Angle degree	OR Outer Radius mil / μ m	BTNK Height mil / μ m
2.2 / 55	0.8 / 20	1.6 / 41	3.0 / 76	1.1 / 28	1.4 / 36	11°	0.3 / 8	8 / 203
2.2 / 55	0.8 / 20	1.5 / 38	3.0 / 76	1.0 / 25	1.3 / 33	11°	0.3 / 8	8 / 203
2.0 / 50	0.8 / 20	1.5 / 38	2.8 / 71	1.1 / 27	1.3 / 33	11°	0.3 / 8	6 / 152
2.0 / 50	0.8 / 20	1.4 / 36	2.8 / 71	1.0 / 25	1.2 / 30	11°	0.3 / 8	6 / 152
1.8 / 45	0.8 / 20	1.4 / 36	2.3 / 58	1.0 / 25	1.2 / 30	11°	0.3 / 8	6 / 152
1.8 / 45	0.7 / 18	1.4 / 36	2.3 / 58	0.9 / 23	1.2 / 30	11°	0.3 / 8	6 / 152



P/NO SYSTEM: STANDARD CAPILLARY

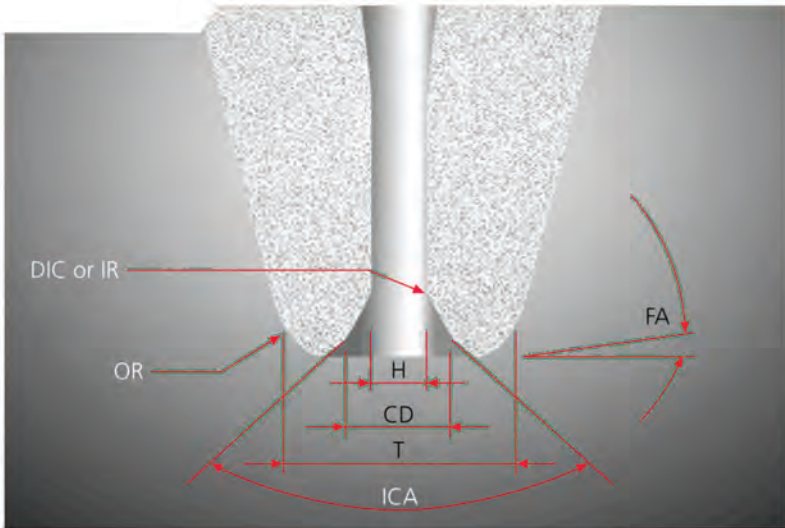
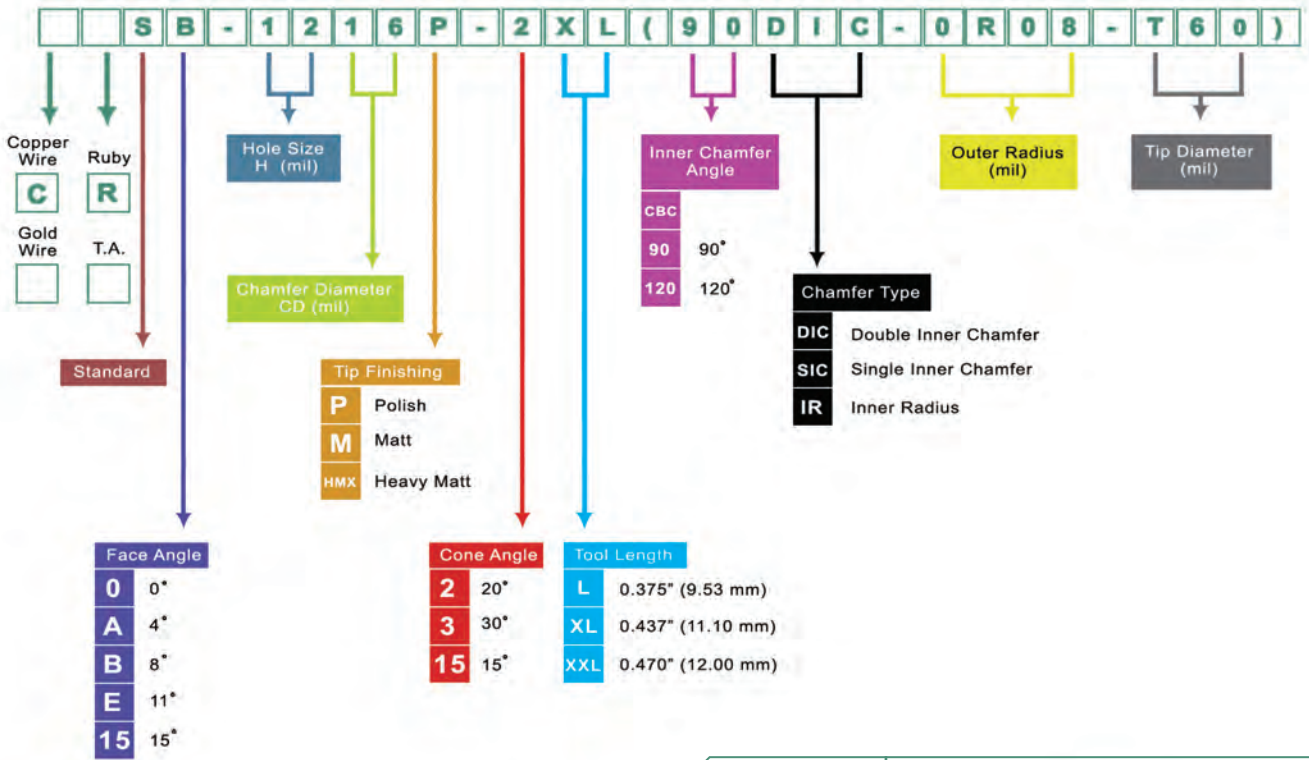

P/NO SYSTEM: FINE PITCH CAPILLARY

(For Bond Pad Pitch 60 μm and above)

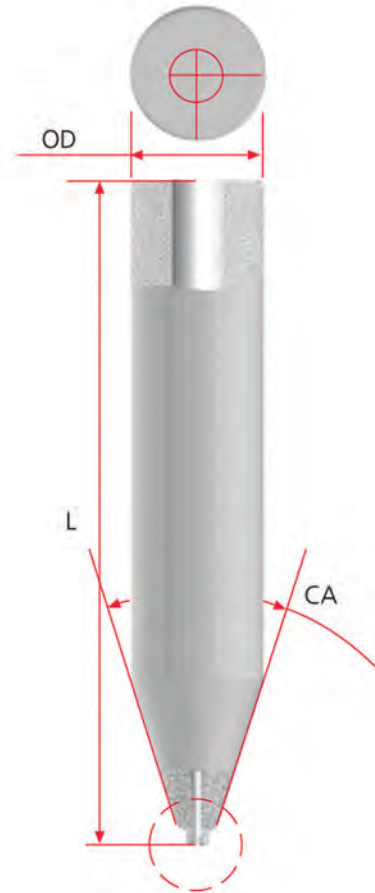
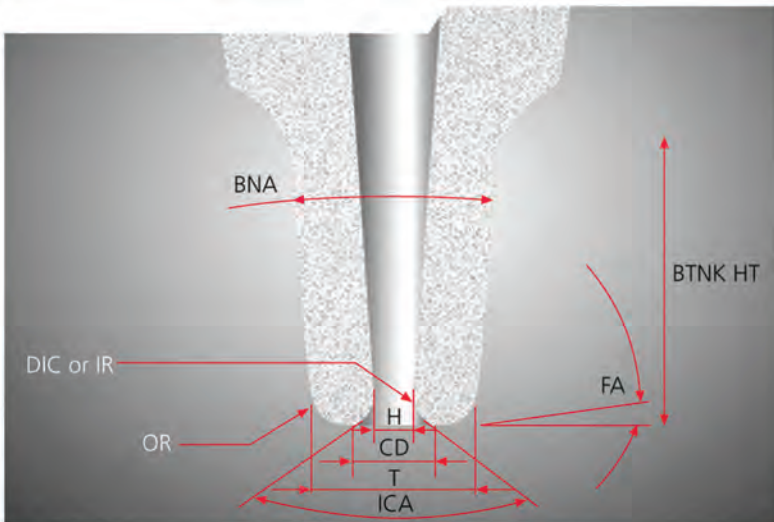
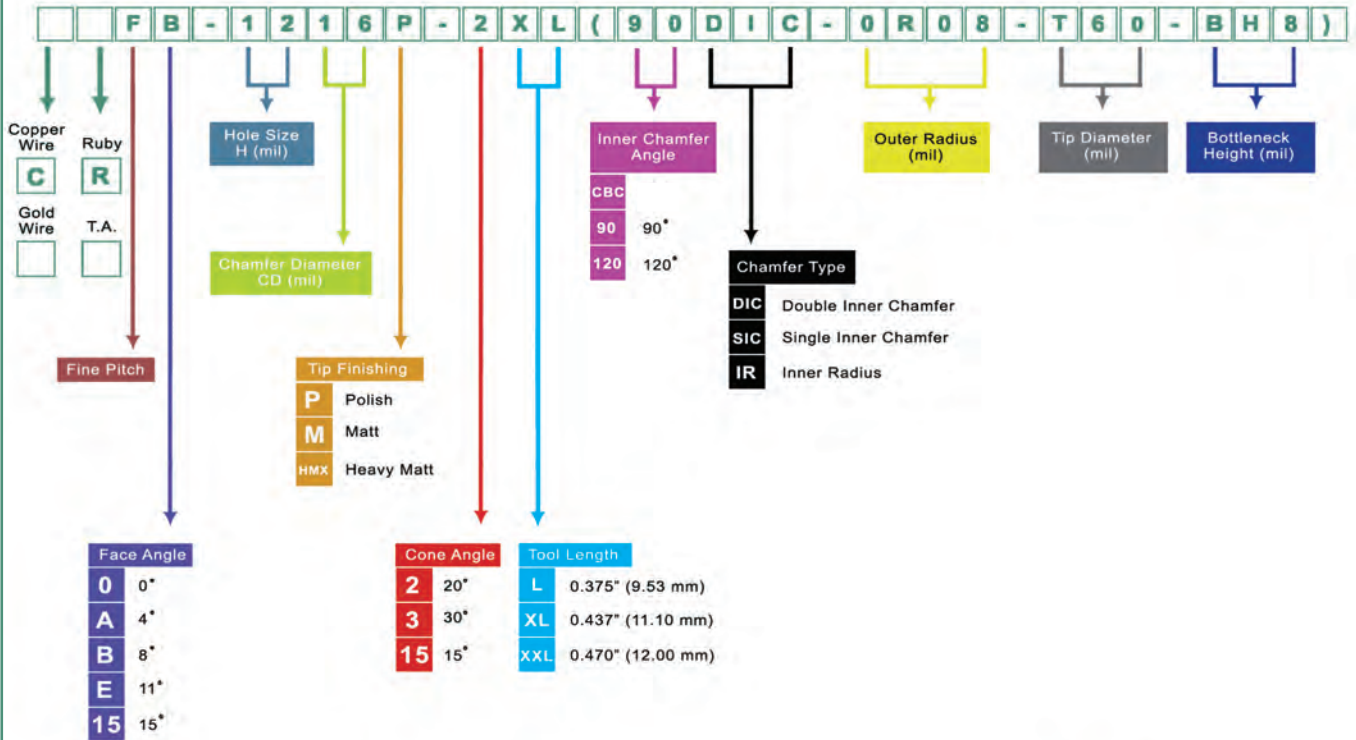

P/NO SYSTEM: ULTRA FINE PITCH CAPILLARY

(For Bond Pad Pitch 55 μm and below)

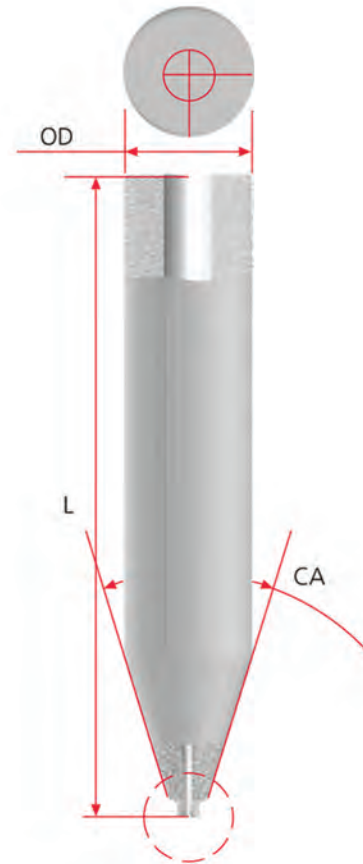
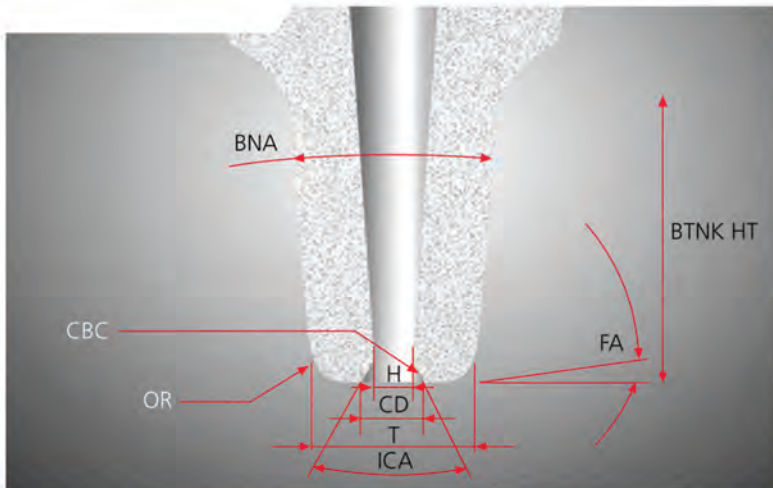
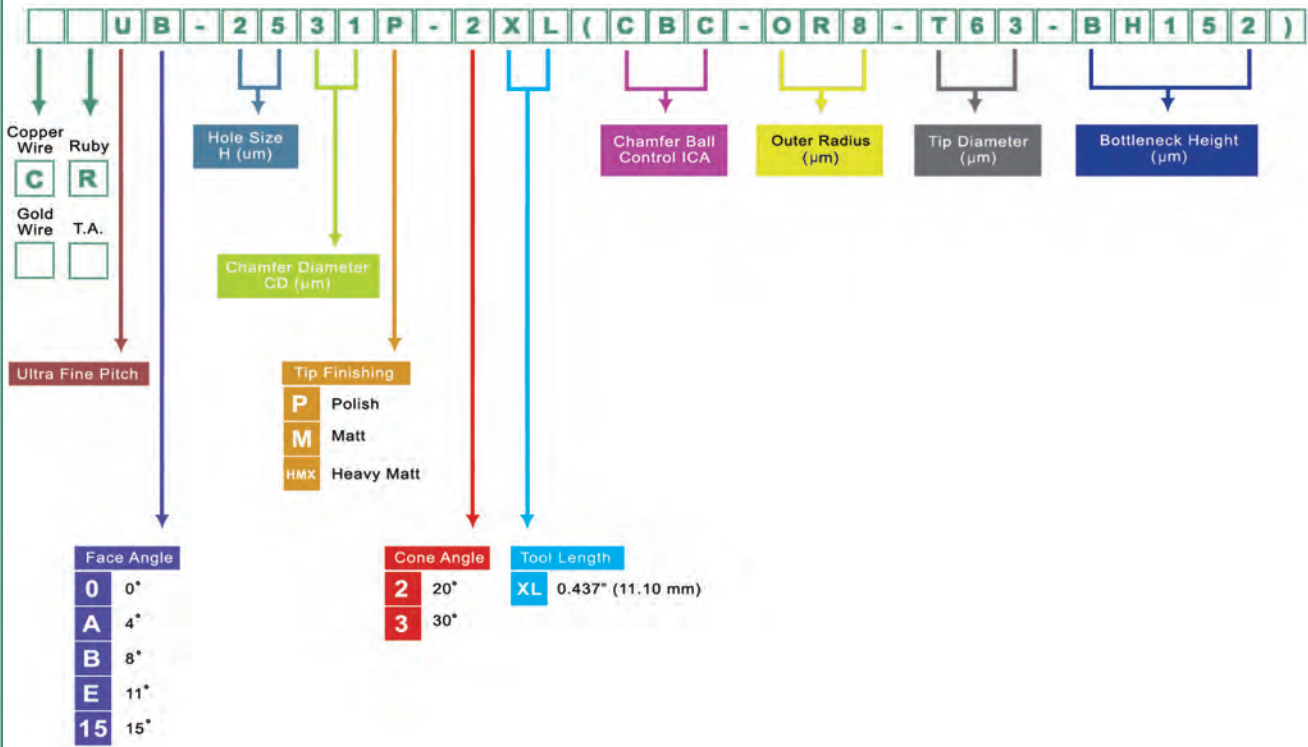

P/NO SYSTEM: VERTICAL BOTTLENECK CAPILLARY

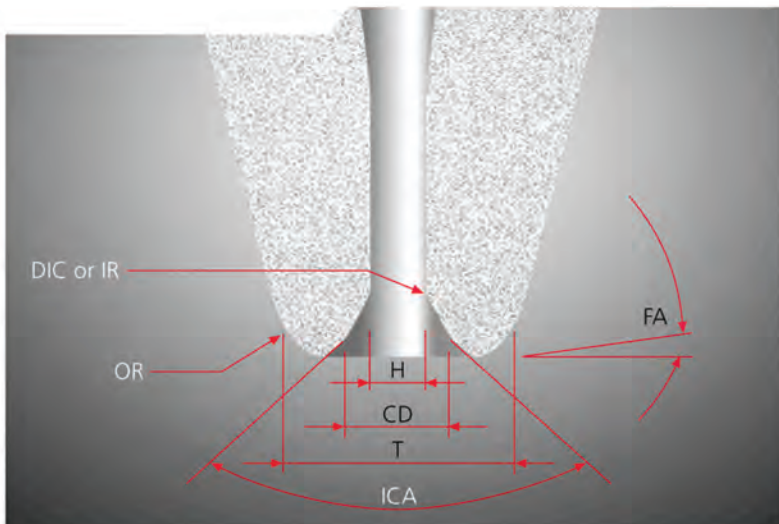
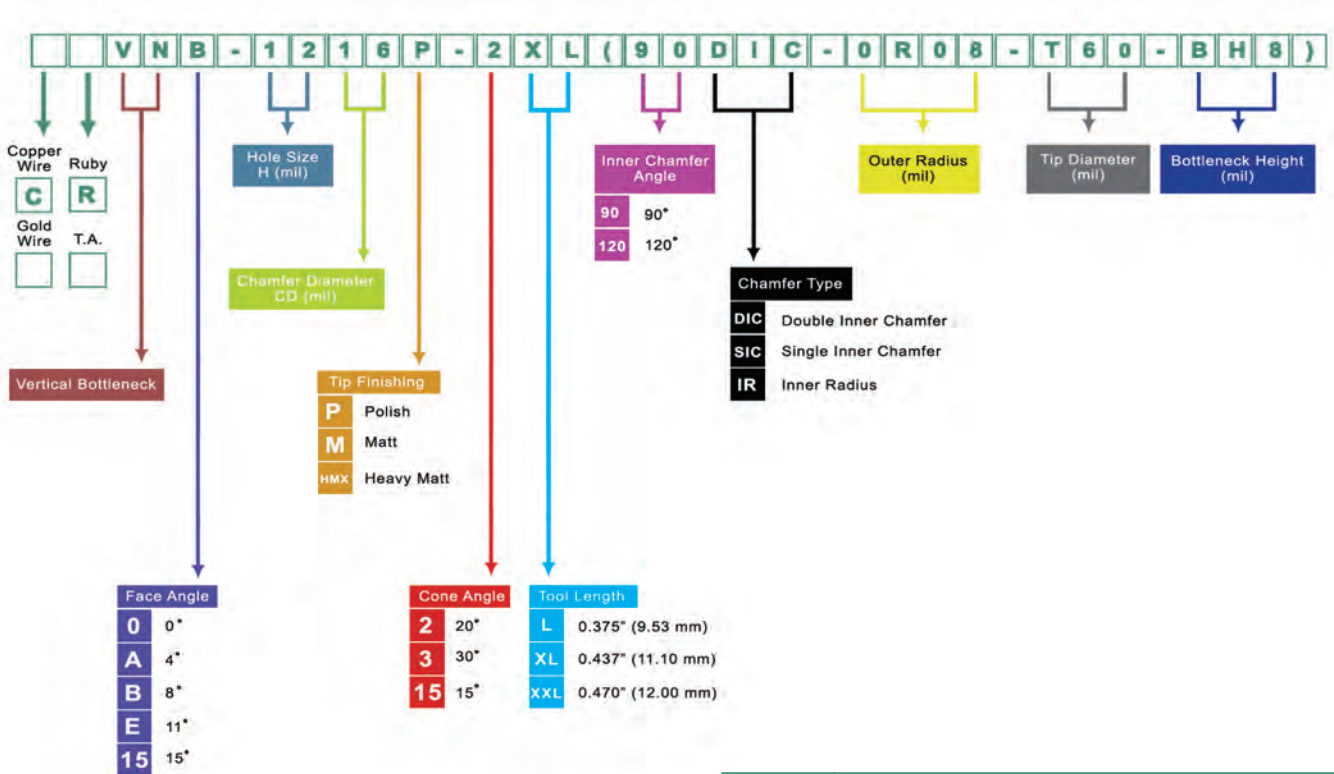

P/NO SYSTEM: RUBY CAPILLARY

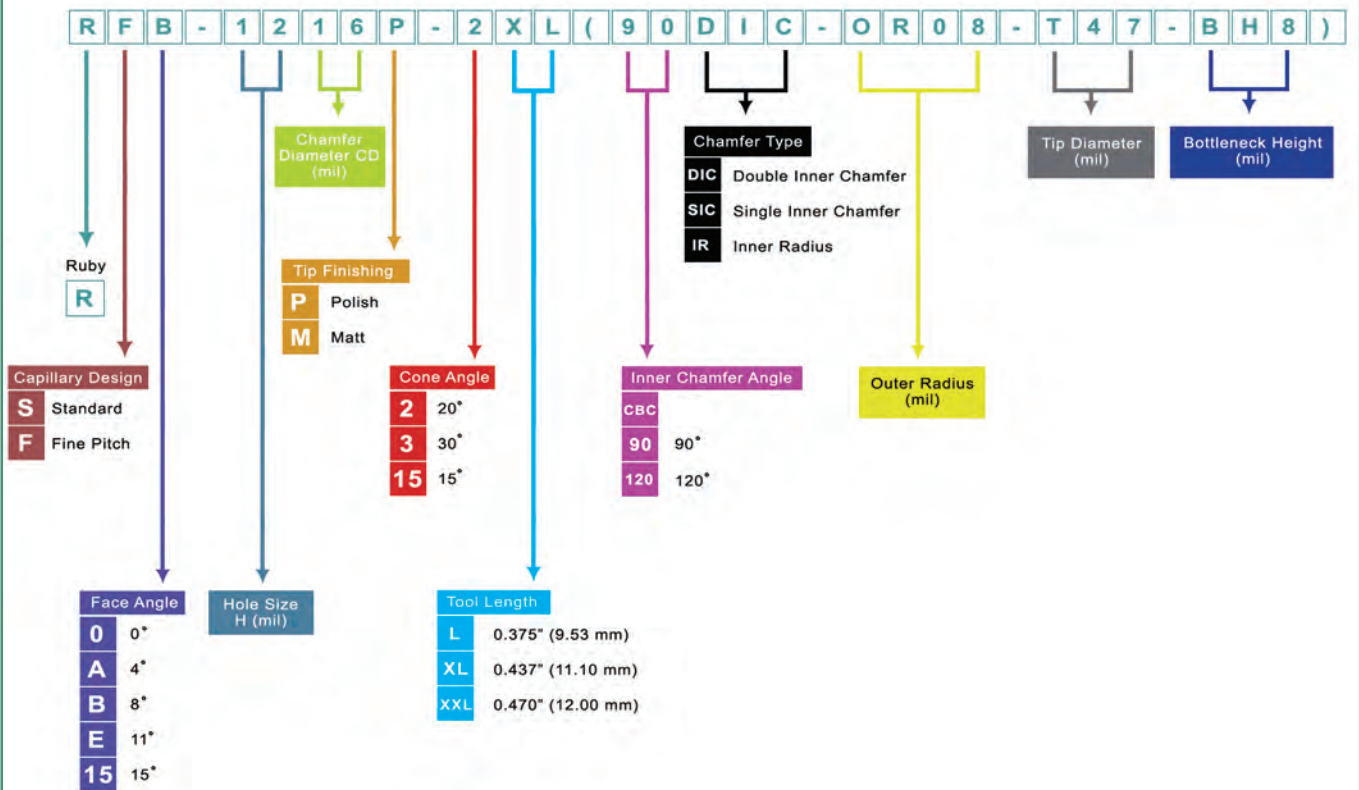

TOLERANCES

Standard Capillary

Critical Dimensions Tolerance	T mil/ μ m	H mil/ μ m	CD mil/ μ m	OR mil/ μ m
T \geq 10 mil/ 254μm	$\pm 0.5 / \pm 13$	+ 0.2 / + 5 - 0.1 / - 3	$\pm 0.2 / \pm 5$	$\pm 0.3 / \pm 8$
T < 10 mil/ 254μm	$\pm 0.3 / \pm 8$	$\pm 0.1 / \pm 3$	$\pm 0.2 / \pm 5$	$\pm 0.2 / \pm 5$

Fine Pitch Capillary

Critical Dimensions Tolerance	T mil/ μ m	H mil/ μ m	CD mil/ μ m	OR mil/ μ m
	$\pm 0.2 / \pm 5$	+ 0.1 / + 3 or - 0.1 / - 3	+ 0.1 / + 3 or - 0.1 / - 3	$\pm 0.2 / \pm 5$

Ultra Fine Pitch Capillary

Critical Dimensions Tolerance	T μ m	H μ m	CD μ m	OR μ m
	± 3	+ 2 - 0	+ 2 - 0	± 3

Vertical Bottleneck Capillary

Critical Dimensions Tolerance	T mil/ μ m	H mil/ μ m	CD mil/ μ m	OR mil/ μ m
T \geq 10 mil/ 254μm	$\pm 0.5 / \pm 13$	+ 0.2 / + 5 - 0.1 / - 3	$\pm 0.2 / \pm 5$	$\pm 0.3 / \pm 8$
T < 10 mil/ 254μm	$\pm 0.3 / \pm 8$	$\pm 0.1 / \pm 3$	$\pm 0.2 / \pm 5$	$\pm 0.2 / \pm 5$

OD, Tool Length Tolerance

Outer Diameter (OD) :- Standard 1.587mm + 0.000 / - 0.008 (0.0625" + 0.0000 / - 0.0003)
 Tool Length :- L = 9.53mm + / - 0.050 (0.375" + / - 0.002)
 XL = 11.10mm + / - 0.050 (0.437" + / - 0.002)
 XXL = 12.00mm + / - 0.050 (0.470" + / - 0.002)

For capillary design for specific applications, please consult manufacturer.

CAP CLEANING SERVICE

Dou Yee's high acid resistance ceramic material renders itself suitable for capillary cleaning. Quality of cleaned capillary is comparable to a brand new capillary.

Hence, same bonding responses, same tool life can be achieved with the cleaned capillary. Substantial cost savings can therefore be achieved with capillary cleaning program with Dou Yee capillary.

End of Tool Life Capillary
(Before Clean)

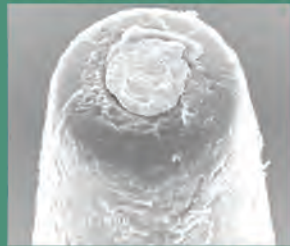
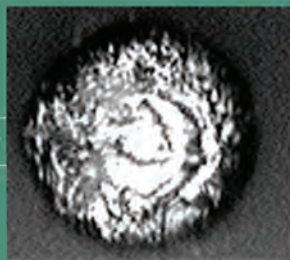

After Clean

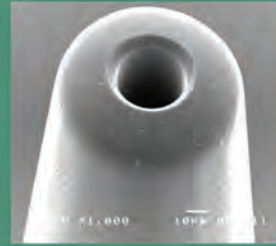

EDX of Cleaned Capillary (No residue found, only ceramic elements)

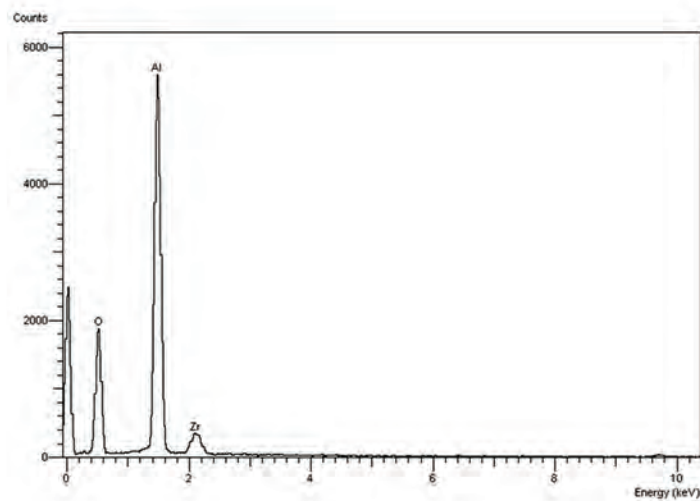

UNPLUG WIRE

The unplug wire helps to unclog the capillary hole of contamination stuck inside during wire bonding processes consisting of a hard tapered wire. Unplugging is done with the capillary still mounted onto the bonder transducer.



How To Use

To unplug a plugged capillary, we need to insert the wire with the taper end into the plugged capillary (figure 1).

The bonder setting need to be set at USG calibration mode to provide ultrasonics vibration to loosen the dirt inside the capillary.

Then, gently push the wire into the capillary as shown in figure 1 until we can see taper end of the wire protrude out of the capillary tip.



Figure 1

Before
Unplug

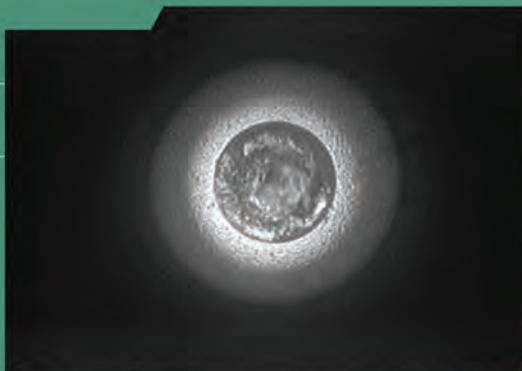

After
Unplug



PACKING INFORMATION/ COLOUR CODING/ BAR CODE LABEL

Dou Yee capillaries are packed in 50s per box. Part numbers are clearly labelled on the capillary vial and on the box.

Dou Yee also offer color coding on capillaries and colored vial corks to provide instant identification on the capillaries used on production lines.

Colors available are red, purple, blue, green, orange, yellow and brown.

Upon customer's request, Dou Yee also provides bar code labelling.



CAPILLARY REQUEST FORM

Date : _____

Company Name : _____

Department : _____

Customer Name : _____

Office Phone No. : _____ Extn: _____

Handphone No. : _____

Email : _____

Package : _____

Lead Count : _____

Bonder/ Model # : _____

Wire Type : Gold Copper

Wire Diameter : _____ (mils)

Bond Pad Pitch : _____ (μm)

Bond Pad Opening : _____ (mils)

Target 1st Bond Diameter : _____ (mils)

Loop Height : _____ (mils)

2nd Bond Metallisation : _____

Current Capillary P/No. : _____

Current Wire Bonding Problem : _____

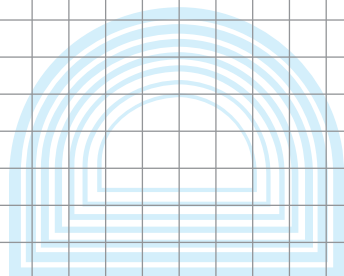
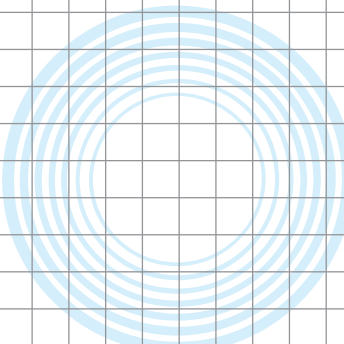
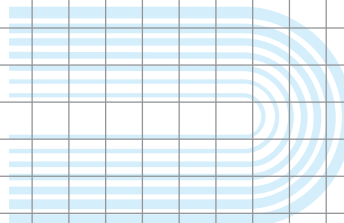
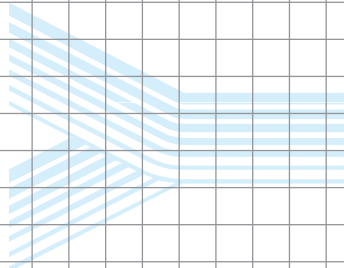
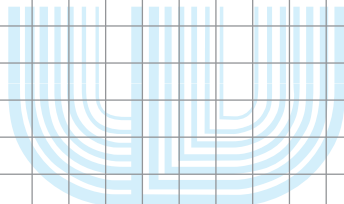
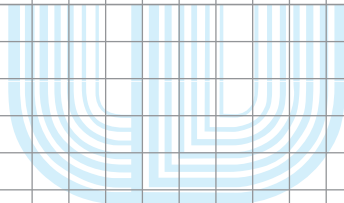

HEAD OFFICE

Singapore

2304 Bedok Reservoir Road Bedok Industrial Park C Singapore 479223
Tel: (65) 6444 2678 Fax: (65) 6743 7172 Email: s5_marketing@douyee.com.sg
Website: www.douyee.com

OVERSEAS OFFICES

MALAYSIA

Johor Bahru
No. 131 & 131A, Jalan Seri Impian
1, Taman Impian Emas,
81300 Johor Bahru, Malaysia.
Tel: (607) 556 6284 / 558 6285
Fax: (607) 556 6273
Email: jhbsales1@douyee.com.my

Malacca

No. 13 and 13-1, Jalan Puncak 2,
Taman Puncak, Bukit Katil,
75450 Melaka, Malaysia.
Tel: (606) 231 5060/61/62/64
Fax: (606) 231 5059
Email: mlcsales@douyee.com.my

Kuala Lumpur

No 26 Shah Alam Technology Park,
Jalan Tamborin 33/23, Sek. 33,
40460 Shah Alam,
Selangor, Malaysia.
Tel: (603) 5121 1613 / 14
Fax: (603) 5121 8121
Email: dysales@douyee.com.my

Penang

18 Lorong Talang 8, Taman Emas,
13600 Perai, Penang, Malaysia.
Tel: (604) 390 4824
Fax: (604) 390 3815
Email: pngsales1@douyee.com.my

Ipoh

79 Persiaran Klebang,
Kawasan Perusahaan IGB,
Off Jalan Kuala Kangsar,
31200 Ipoh, Perak, Malaysia.
Tel: (605) 2911853
Fax: (604) 390 3815
Email: pngsales9@douyee.com.my

Sarawak

Ground Floor SL2,
Samajaya Commercial Centre
Jalan Setia Raja, 93350
Kuching Sarawak
Tel : (082)-262518
Fax: (082)- 363517
Email: dennis.ngu@douyee.com.my

THAILAND

75/27 Moo 11, Phaholyothin Rd,
T.Klongnueng, A.Klongluang,
Pathumthani 12120, Thailand
Tel: (662) 529 0979
Fax: (662) 9081820
Email: mkt.thailand@douyee.co.th

VIETNAM

Ho Chi Minh
2nd Floor, Fimexco Building,
231-233 Le Thanh Ton Street,
Ben Thanh Ward, District 1,
Ho Chi Minh City, Vietnam
Tel: (84) 8 3910 4420
Fax: (84) 8 3910 4419
Email: vnmsales1@douyee.com.sg

Hanoi

P902, 49A Le Van Huu,
Hai Ba Trung, Hanoi, Vietnam
Tel: (844) 6275 4337
Fax: (844) 6275 4337
Email: vnmsales2@douyee.com.sg

CHINA

Shanghai
1st Floor, Block B, Hi-Tech Industrial
Center, No. 559, NingQiao Road,
JinQiao, PuDong District (New),
ShangHai 201206
Tel: +86-21-5899 4619
Fax: +86-21-5899 4618
Email: dysh@douyee.com.cn

Suzhou

No. 58, West Shen Hu Road, Suzhou
Industrial Park, 215123 China Tel:
+86-512-6258 5066
Fax: +86-512-6258 5366
Email: ongccc@douyee.com.sg

Beijing

#6010, Block 2, Chunlan Building,
No.88, Nan San Huan road (west),
Feng Tai District, Beijing
100070 China
Tel: +86-10-8368 6931
Fax: +86-10-8368 7651
Email: dybj@douyee.com.cn

Tianjin

#202, SenTe Building,
YuRong GardenJinZhong River Street,
HeBei District, TianJin
300150 China
Tel: +86-22-2642 2093
Fax: +86-22-2642 2023
Email: dytj@douyee.com.cn

Dalian

#607, No.263, Huanghe Road, Xigang
District, Dalian 116011 China Tel:
+86-411-8377 9121 / 9193 Fax:
+86-411-8369 5216
Email: dydl@douyee.com.cn

Chengdu

Unit #C1409, XieWang Building, No.
9, XieDu Road (South),
1st Avenue, ChengShuang Section,
ChuanZang Road, WuHou District,
ChengDu 610043 China
Tel: +86-28-8501 7691
Fax: +86-28-8501 7693
Email: dydc@douyee.com.cn

Xi An

#401, Unit 3, Block 8, No.306, JiXiang
Road,Southern suburb, XiAn 710063
China
Tel: +86-29-8824 7085
Fax: +86-29-8824 7085
Email: dyxa@douyee.com.cn

Anhui

#2607, Block 7,
West Ring Central Plaza, Huangshan
Road (West),
Shushan District, Hefei 230000 China
Tel: +86-21-5899 4619
Fax: +86-21-5899 4618
Email: dyah@douyee.com.cn

Shenzhen

Unit #13-F, JinSong Building,
Terra 4th Road, Che Gong Miao,
FuTian District, ShenZhen
518040 China
Tel: +86-755-8389 0255
Fax: +86-755-8389 0675
Email: dysz@douyee.com.hk

HONG KONG

Room #6, 8th Floor, Vanta Industrial
Centre, No. 21-33,
Tai Lin Pai Road, Kwai Chung, N.T.,
Hong Kong China
Tel: +852-2480 6337
Fax: +852-2487 7956
Email: dyhk@douyee.com.hk

TAIWAN

Taipei
5F-2, No. 328, Chang Chun Road,
104 Taipei, Taiwan
Tel: (886) 2 2715 1156
Fax: (886) 2 2712 8570
Email: deamer.wu@douyee.com.tw

HsinChu

Rm. 1, 20F., No.295, Sec. 2, Guangfu
Rd., Hsinchu City 30071, Taiwan
Tel: (886) 3571 1618
Fax: (886) 3571 1619
Email: deamer.wu@douyee.com.tw

PHILIPPINES

Manila
#1105-1108 Richville Corporate Tower
Madrigal Business Park,
Alabang-Zapote Road Alabang,
Muntinlupa City 1770, Philippines
Tel: (+632) 807 4683 / 84 / 85
Fax: (+632) 807 4682
Email: easy.cunanan@douyee.com.ph

Cebu

Room 204, Lilang's Guitar Building
Quezon National Highway, Brgy.
Pajo Lapu-Lapu City 6015, Cebu
Philippines.
Tel: (6332) 341 1577 / 0147
Fax: (6332) 340 7686
Email: phsales3@douyee.com.ph

INDONESIA

Jakarta
Menara Pasifik Lt.3 Ruang 6,
Jl.MH.Thamrin Kav.107, Lippo
Cikarang, Bekasi 17550 Jawa Barat.
Tel: (6221) 8990 1153
Fax: (6221) 8990 5101
Email: ptdouyee@douyee.com.sg

Batam

Batamindo Shophouse Blk C #01-16,
Mukakuning Batam, 29433 Indonesia
Tel: (011) 7 7061 2490
Fax: (011) 7 7061 2489
Email: btmsales3@douyee.com.sg

JAPAN

Yokohama
2 Tsurumi Building,
302, 2-10-34 Kita-Saiwai,
Nishi-ku, Yokohama,
Kanagawa 220-0004, Japan
Tel: (8145) 312 9906
Fax: (8145) 312 9907
Email: mktg@douyee.co.jp

KOREA

The Sharp First World,
unit F-1402, Songdo-dong,
Yeonsu-gu, Incheon city,
Korea, 406-743
Tel: (82) 10 26984161
E-mail: leeys@douyee.com.sg

UNITED STATES

Truckee, CA
15570 Glenshire Drive,
Truckee, CA 96161-1302
Tel: (530) 320 1313
Email: don.boehm@douyee.com

Murphys, CA

PO Box 736
Murphys, CA 95247
Tel: 209-822-0121
Email: rj.sturgeon@douyee.com

FRANCE

Tournefeuille
94 Chemin De La Peyrette,
31170 Tournefeuille, France
Tel: +33 561 16 2050
Fax: +33 534 57 5130
Email: info.fr@douyee.fr

Pont de Poitte

45 route d'Orgelet,
39130 Pont de Poitte France
Tel: +33 3 84 87 02 39
Fax: +33 3 84 48 30 00
Email: info.fr@eurostatgroup.com

SWEDEN

Rudsjöterrassen 3,
136 40 Handen, Sweden
Tel: +46 (0) 10 690 06 20
Fax: +46 (0) 10 690 06 21
Email: info.se@eurostatgroup.com

THE NETHERLANDS

Heuvel 6A
5664HK Geldrop
Tel: 088-6363555
Fax: 088-6363563
Email: info.nl@eurostatgroup.com

UNITED KINGDOM

England
Unit 2, Capital Court
Bittern Road, Sowton
EXETER, EX2 7FW, ENGLAND
Tel: +44 (0) 139 235 7548
Fax : +44 (0) 139 226 8167
Email: info.uk@eurostatgroup.com

POLAND

56-400 Oleśnica, Poland
Tel: +48 500 436 293
Email: info.pl@eurostatgroup.com

HUNGARY

H-1120 Dunakeszi
Baratsag u. 40/C, 4/9
Tel: +36 70 609 4216
Email: info.hu@eurostatgroup.com

SLOVAKIA

Podzhradna 4
82107 Bratislava – Slovakia
Tel: +421 908 581 747
Email: info.sk@eurostatgroup.com